

GONDEL MODULE
 GONDOLA MODULES
 GONDOLE MODULES

2 m

2.01	04
2.02	05

3 m

3.01	06
3.02	07
3.03	08

4 m

4.01	10
4.02	11
4.03	12
4.04	13

6 m

6.01	14
6.02	15
6.03	16
6.04	17
6.05	18
6.06	19

8 m

8.01	20
8.02	21
8.03	22
8.04	23
8.05	24
8.06	25
8.07	26
8.08	27

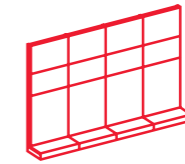

WAND MODULE
 WALL MODULES
 CLOISON MODULES

2 m

2.01	30
2.02	31

3 m

3.01	32
3.02	33
3.03	34

4 m

4.01	36
4.02	37
4.03	38
4.04	39

5 m

5.01	40
5.02	41
5.03	42
5.04	43
5.05	44

6 m

6.01	46
6.02	47
6.03	48
6.04	49
6.05	50
6.06	51

GONDEL MODULE

GONDOLA MODULES
GONDOLE MODULES

NEW

Dieser Artikel ist neu
This item is new
Cet article est nouveau

NEW

In diesem Bereich des Planogrammes hat es Veränderungen gegeben
In this area of the planogrammes changes have been made
Modifications dans le Planogramme

28

Dieser Boden ist zweistufig
This is a double-tiered shelf
Tablette double

11

Diese Zahlen beschreiben, in welchem Loch (von unten gezählt) der Regalboden angebracht werden soll
These figures show in which slot (from bottom to top) the shelf should be inserted

0

Emplacement de la tablette (en partant du bas)

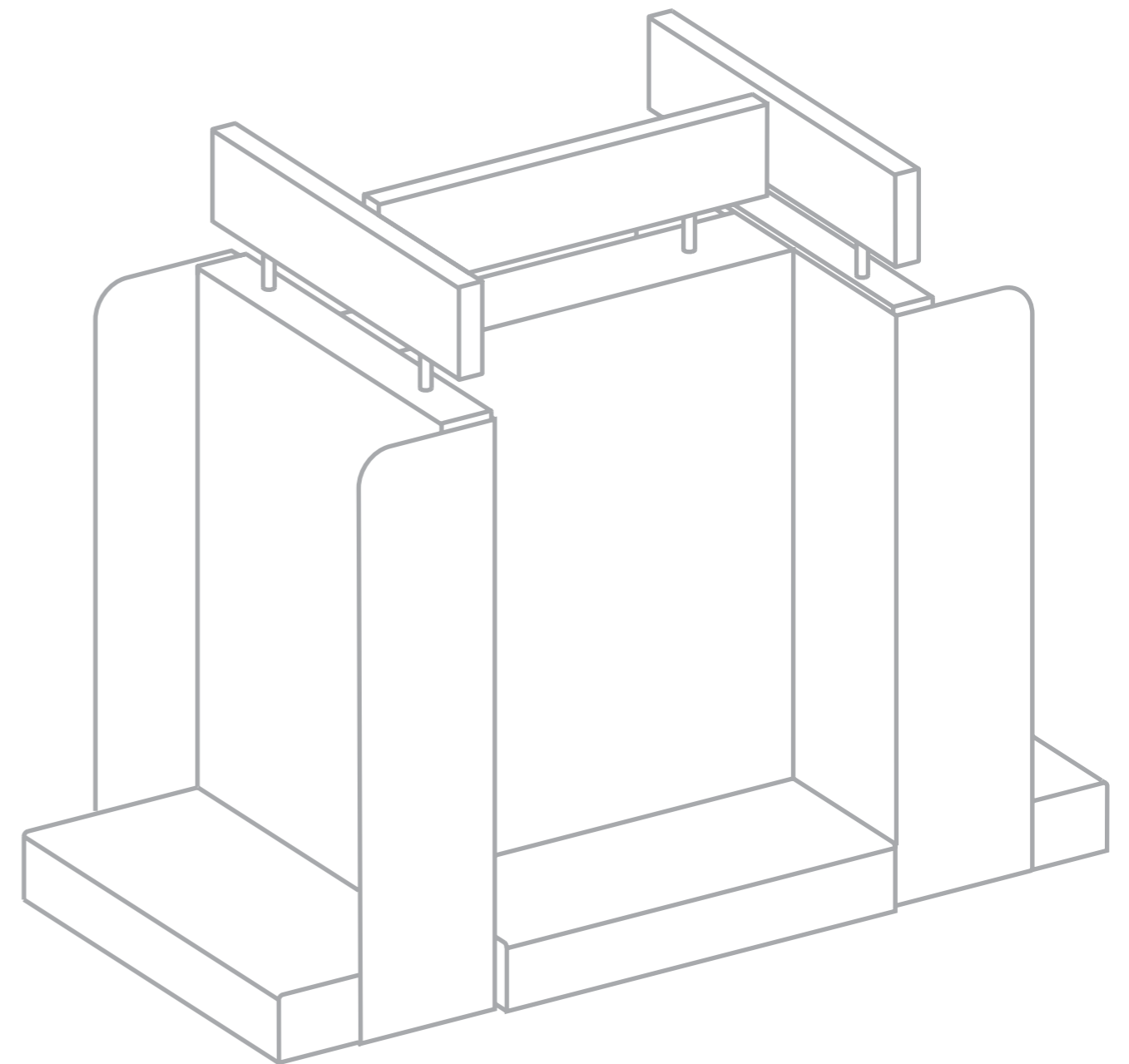

2.01



2 m Gondel, 1. Sektion	Farm Life Bauernhoftiere, Pferde, Kleine Haustiere; Menschen; Zubehör
2 m Gondola, 1. Section	Farm Life Farm Animals, Horses, Small pets; People; Accessories
2 m Gondole, 1. Section	Farm Life Animaux de la ferme, Chevaux, Animaux dom.; Personnages; Accessoires
	09/2011

28
24
20
16
12
8
0

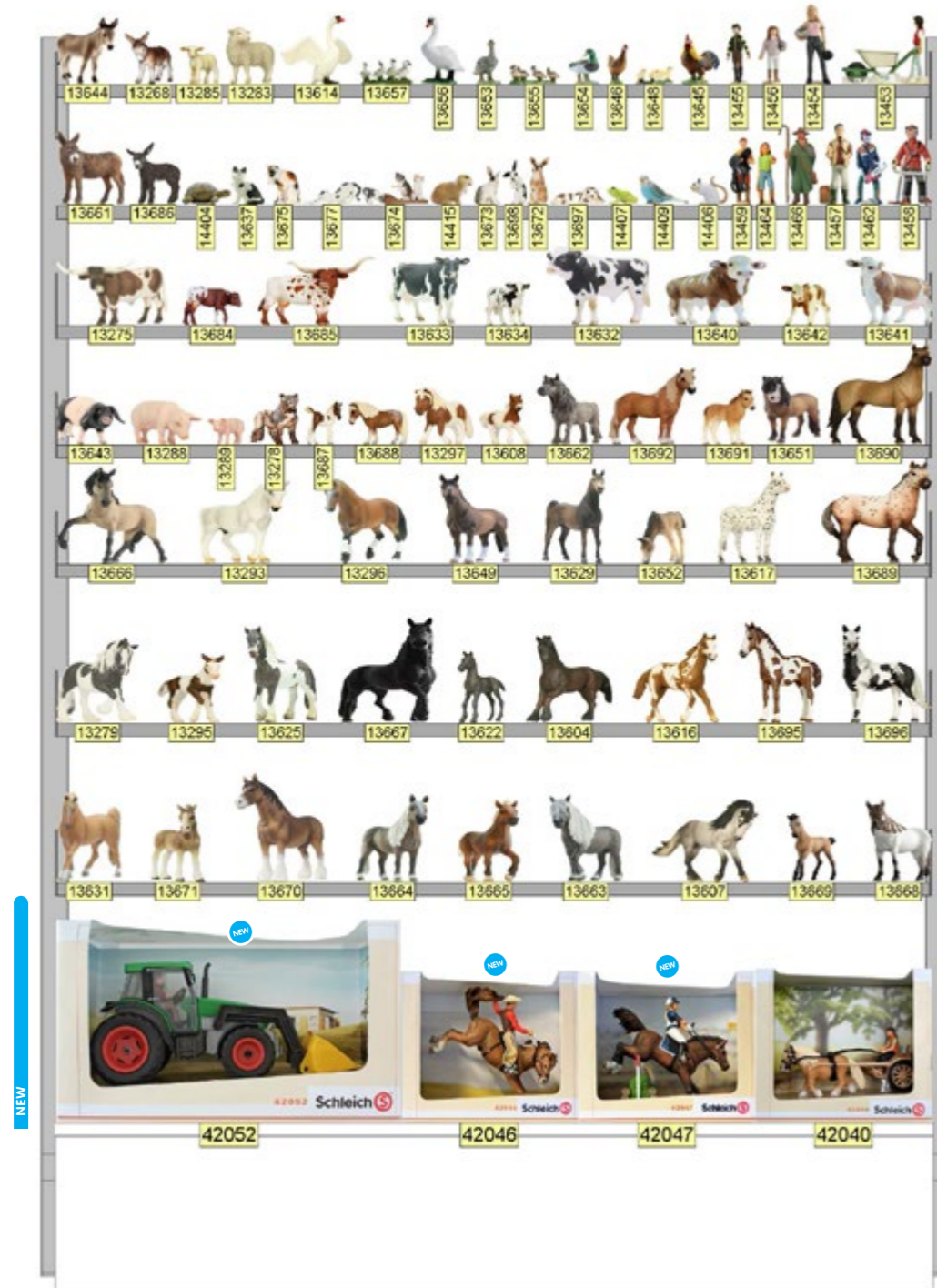

NEW

2 m Gondel, 2. Sektion	Farm Life Hunde; Wild Life; Zubehör
2 m Gondola, 2. Section	Farm Life Dogs; Wild Life; Accessories
2 m Gondole, 2. Section	Farm Life Chiens; Wild Life; Accessoires
	09/2011

2.02

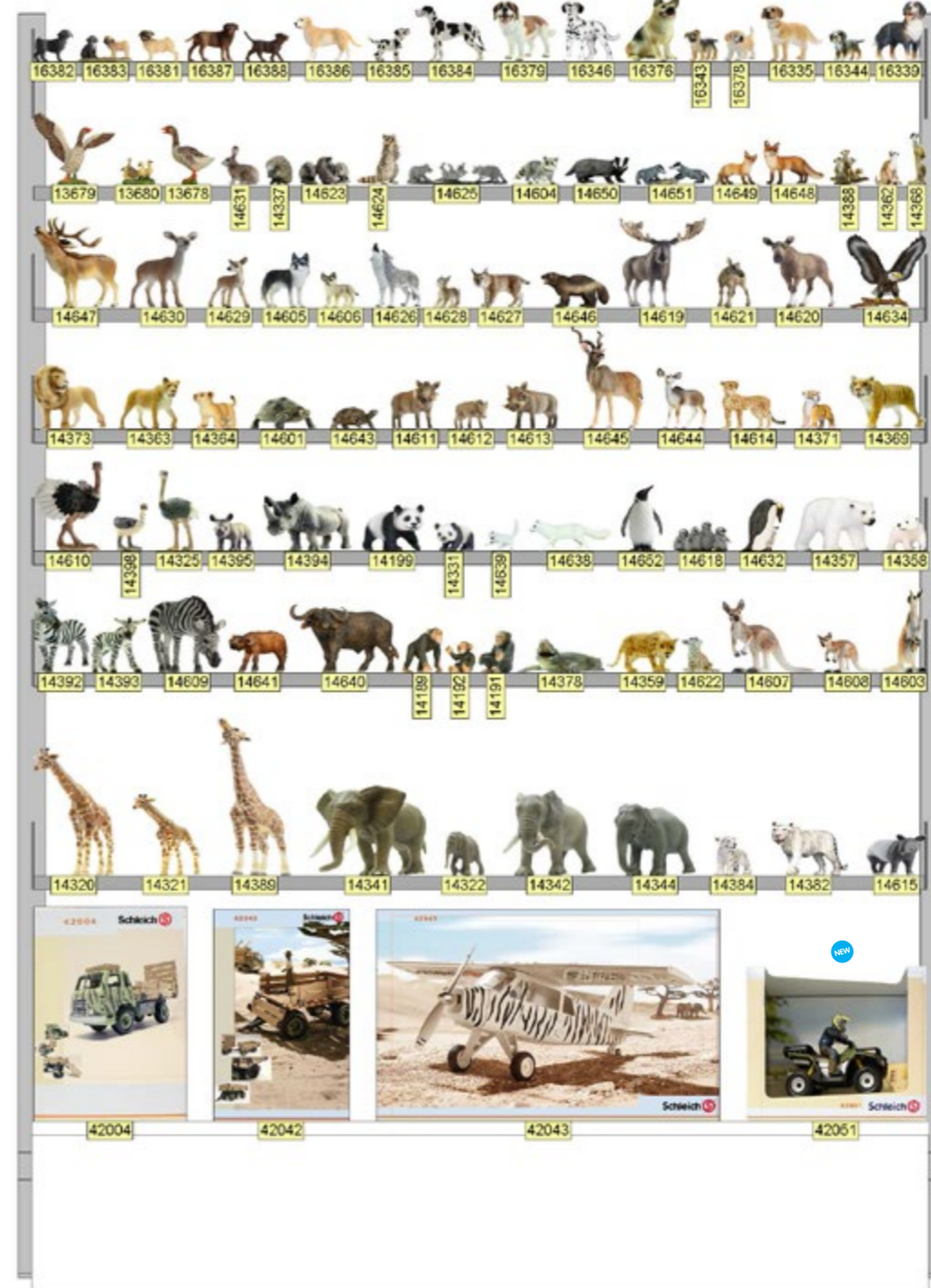
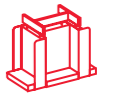

28
24
21
17
14
9
0

NEW

2.01 Gondel / Gondola / Gondole

2.02 Gondel / Gondola / Gondole

3.01



3 m Gondel, 1. Sektion	Farm Life Bauernhoftiere, Pferde, Kleine Haustiere; Menschen; Zubehör
3 m Gondola, 1. Section	Farm Life Farm Animals, Horses, Small pets; People; Accessories
3 m Gondole, 1. Section	Farm Life Animaux de la ferme, Chevaux, Animaux dom.; Personnages; Accessoires
	09/2011

- 28 •
- 24 •
- 20 •
- 16 •
- 12 •
- 8 •
- 0 •

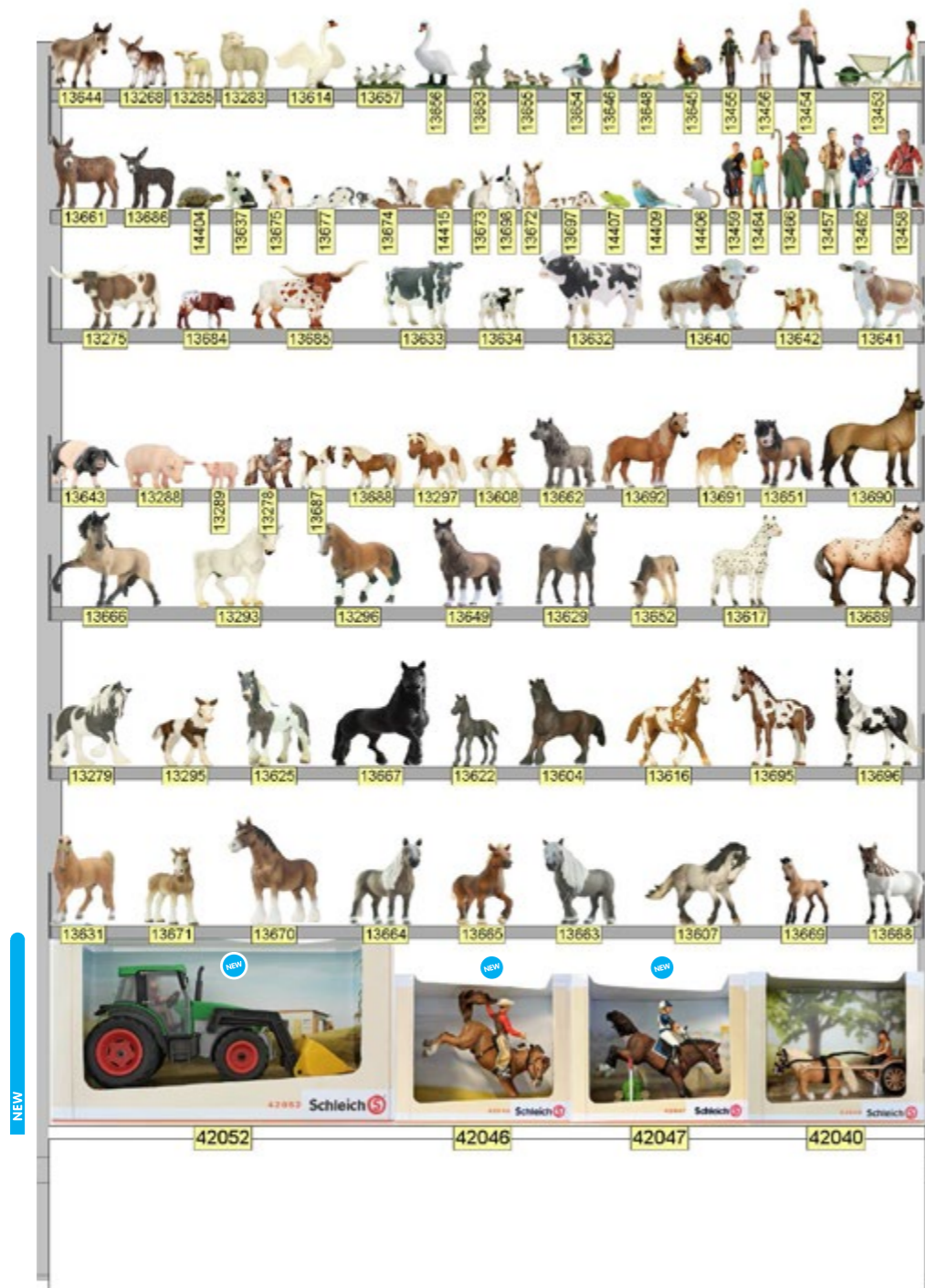

42052 42046 42047 42040

3 m Gondel, 2. Sektion	Farm Life Hunde; Wild Life; Zubehör
3 m Gondola, 2. Section	Farm Life Dogs; Wild Life; Accessories
3 m Gondole, 2. Section	Farm Life Chiens; Wild Life; Accessoires
	09/2011

3.02



3.02 Gondel / Gondola / Gondole

- 28 •
- 24 •
- 21 •
- 17 •
- 14 •
- 9 •
- 0 •

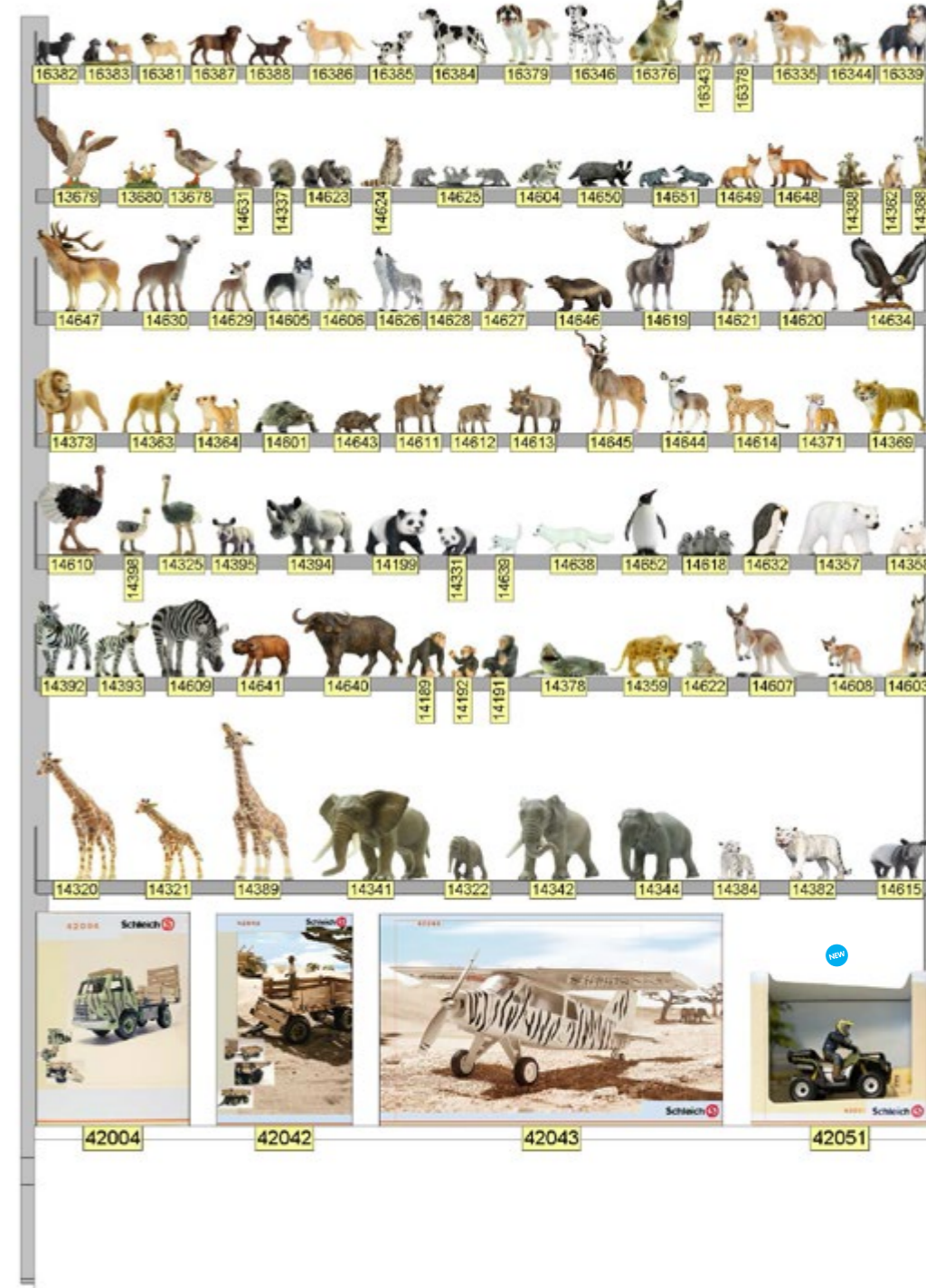

42004 42042 42043 42051

3.03



3 m Gondel, 3. Sektion	Bayala; Helden; Zubehör
3 m Gondola, 3. Section	Bayala; Heroes; Accessories
3 m Gondole, 3. Section	Bayala; héros; Accessoires
	09/2011

3.03 Gondel / Gondola / Gondole

28 ●

23 ●

19 ●

14 ●

9 ●

0 ●

NEW

4.01



4 m Gondel, 1. Sektion	Farm Life Bauernhoftiere, Pferde, Kleine Haustiere; Menschen; Zubehör
4 m Gondola, 1. Section	Farm Life Farm Animals, Horses, Small pets; People; Accessories
4 m Gondole, 1. Section	Farm Life Animaux de la ferme, Chevaux, Animaux dom.; Personnages; Accessoires
	09/2011

28
24
20
16
12
8
0

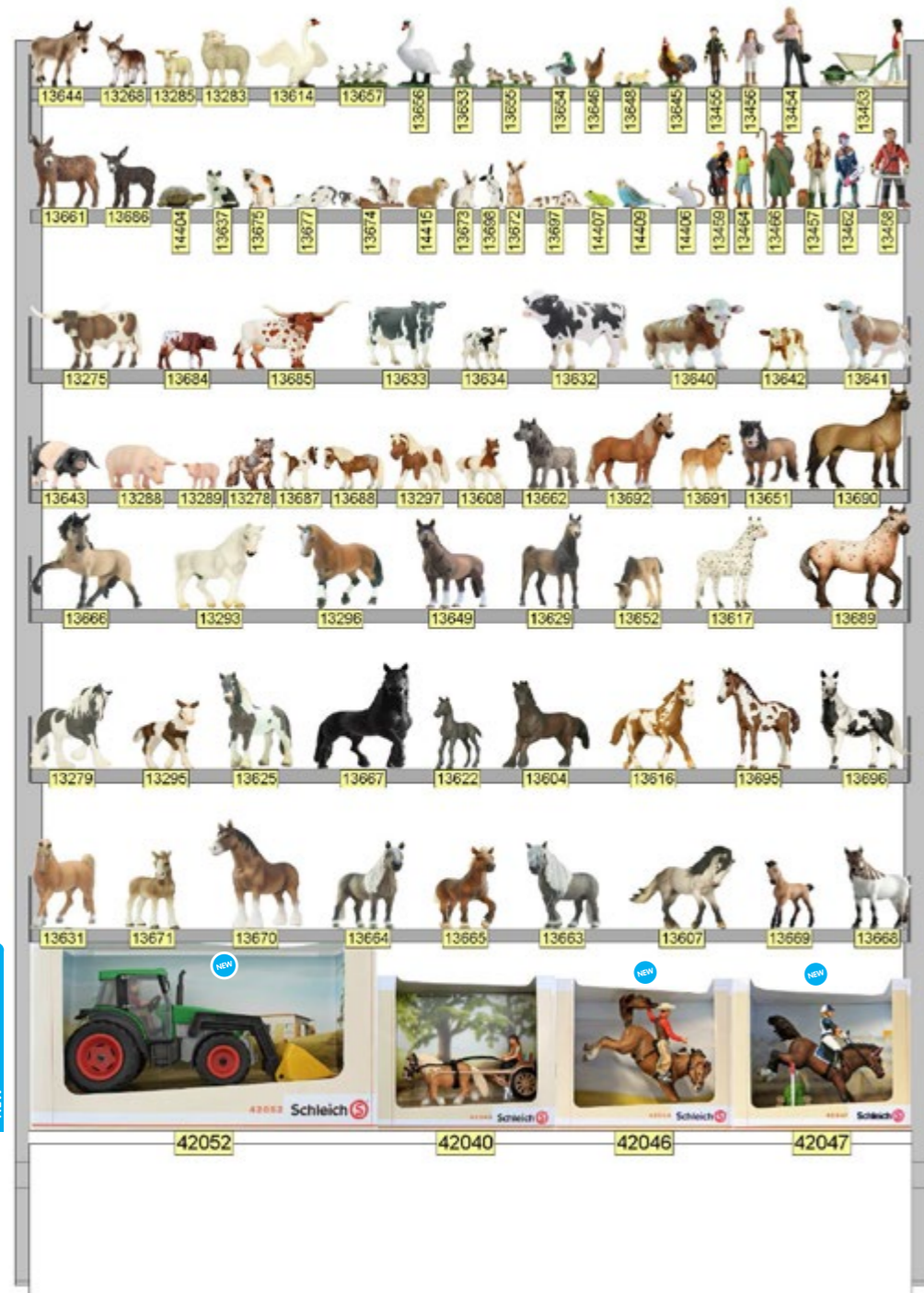

4 m Gondel, 2. Sektion	Farm Life Hunde; Wild Life; Zubehör
4 m Gondola, 2. Section	Farm Life Dogs; Wild Life; Accessories
4 m Gondole, 2. Section	Farm Life Chiens; Wild Life; Accessoires
	09/2011

4.02



4.02 Gondel / Gondola / Gondole

28
24
21
17
14
9
0

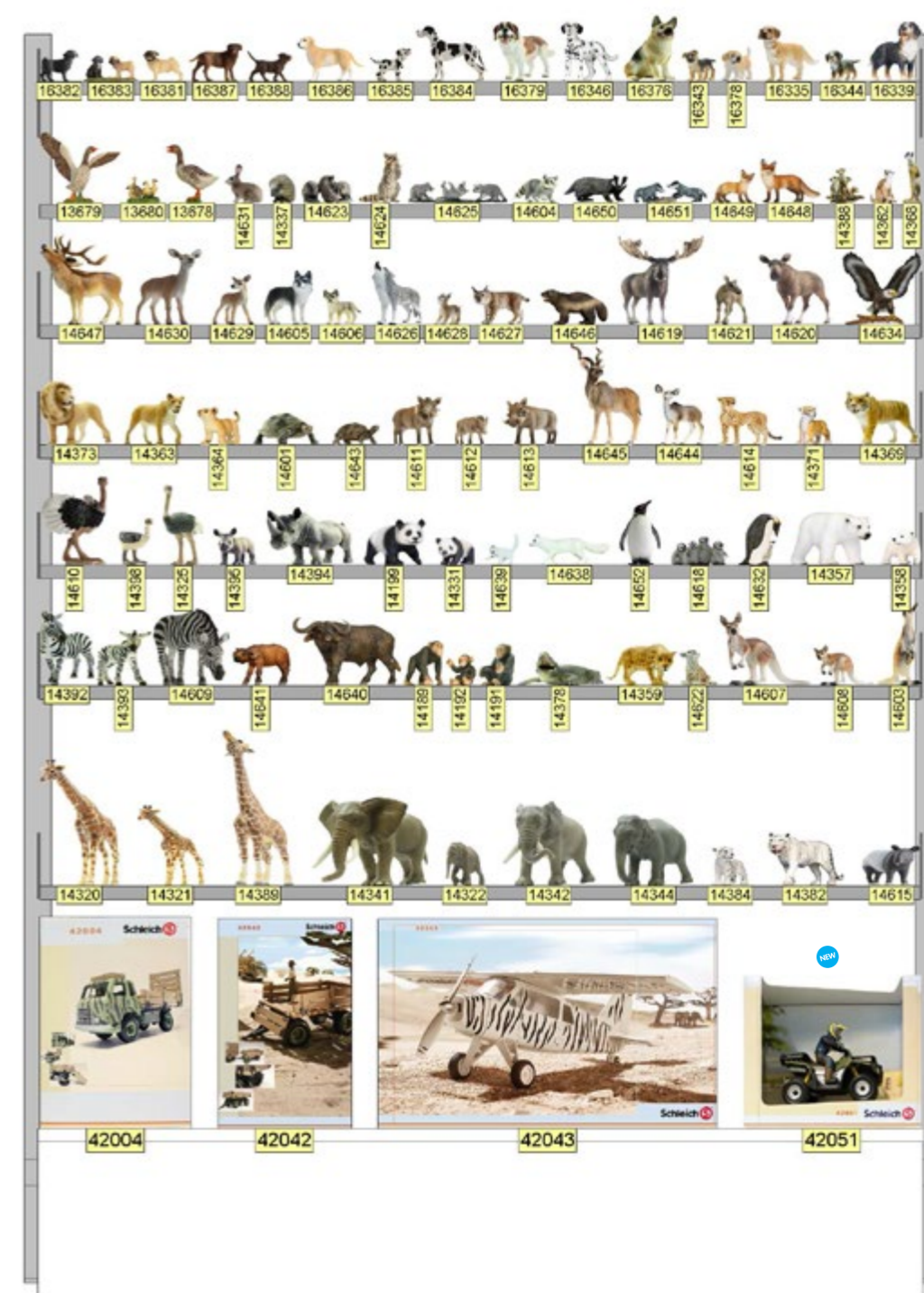

4.03



4 m Gondel, 3. Sektion	Bayala; Helden; Zubehör
4 m Gondola, 3. Section	Bayala; Heroes; Accessories
4 m Gondole, 3. Section	Bayala; héros; Accessoires
	09/2011

28 ●

23 ●

19 ●

14 ●

9 ●

0 ●

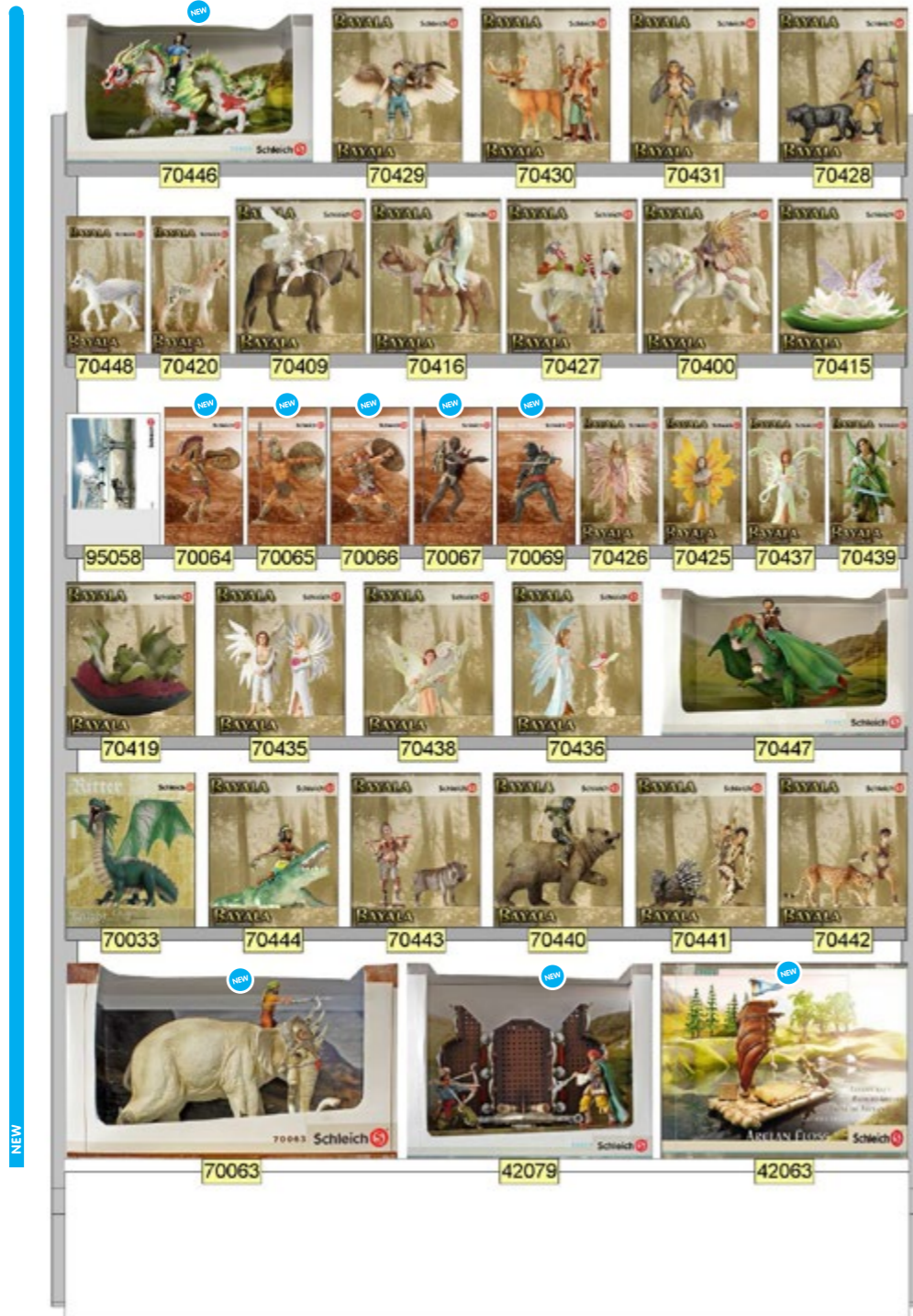

4 m Gondel, 4. Sektion	Urzeittiere; Vitrine; Bayala Zubehör
4 m Gondola, 4. Section	Prehistoric animals; Showcase; Bayala Accessoires
4 m Gondole, 4. Section	Animaux préhistoriques; Vitrine; Bayala Accessoires
	09/2011

4.04

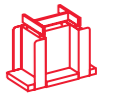

● 28

● 24

● 21

● 12

● 0

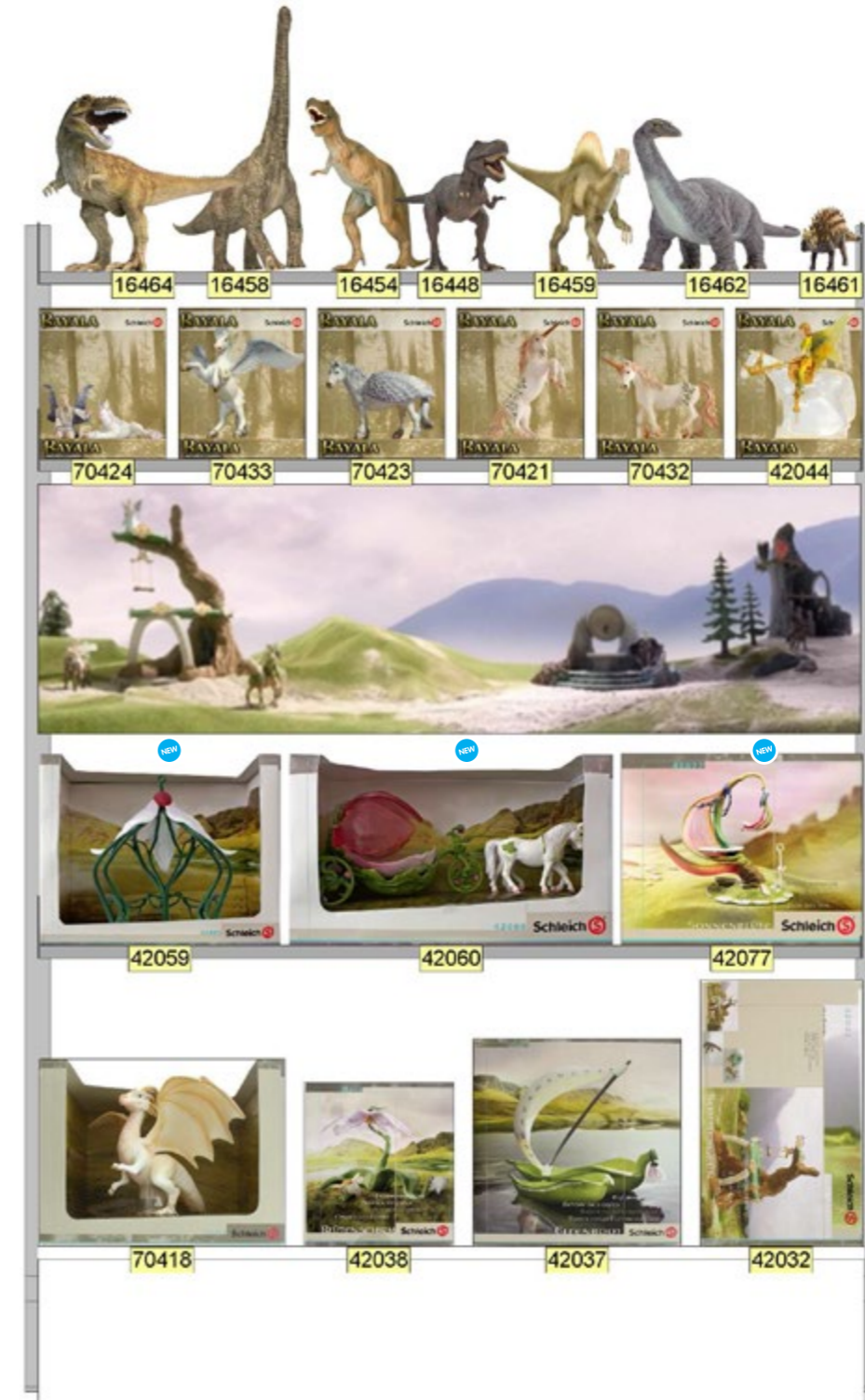

6.01



6 m Gondel, 1. Sektion	Farm Life Pferde; Wild Life Europa, Amerika; Menschen; Zubehör
6 m Gondola, 1. Section	Farm Life Horses; Wild Life Europe, America; People; Accessories
6 m Gondole, 1. Section	Farm Life Chevaux; Wild Life Europe, Amérique; Personnages; Accessoires
	09/2011

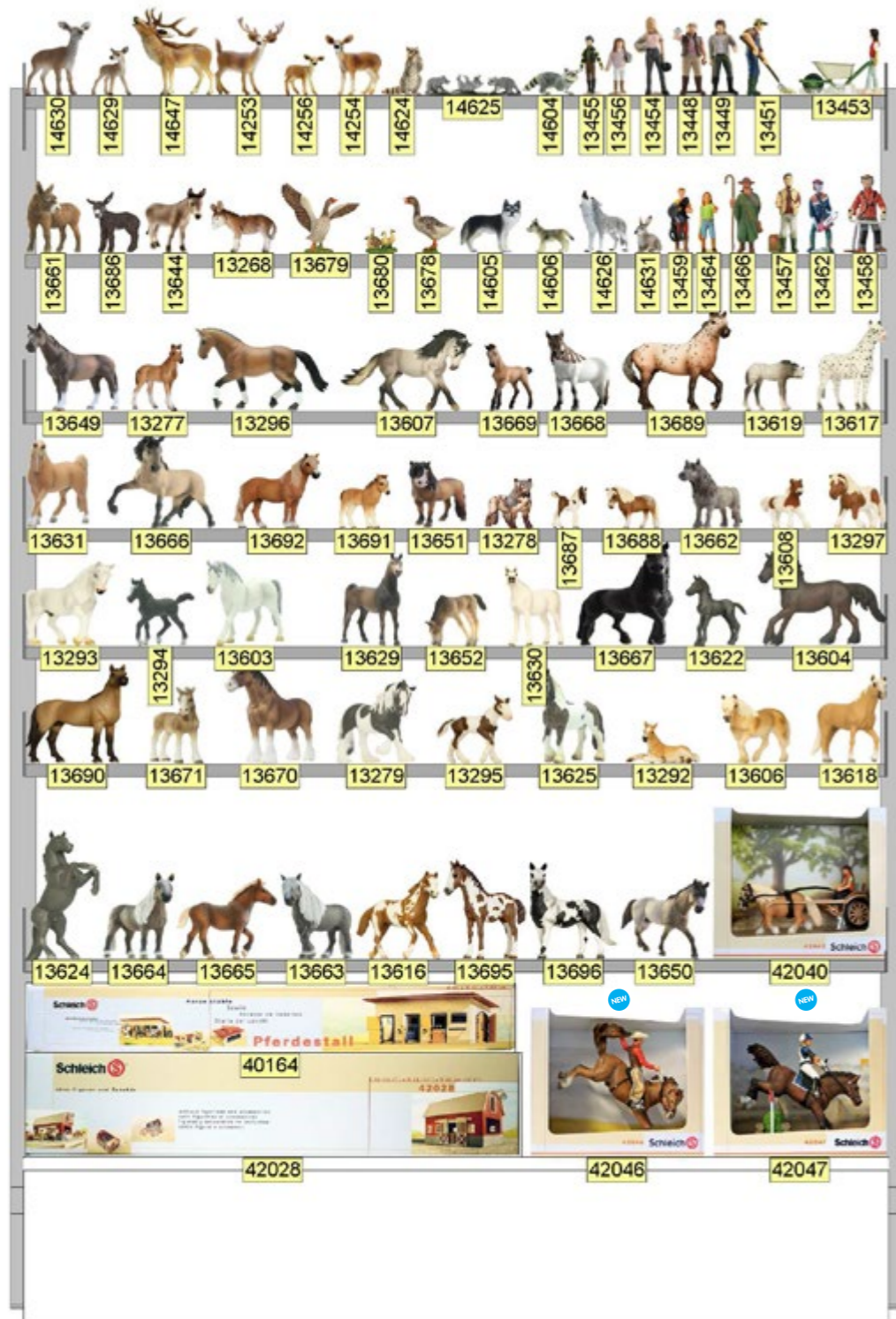

6 m Gondel, 2. Sektion	Farm Life Bauernhof., Kl. Haust.; Wild Life Europa; Zubehör; Pflanzen/Bäume; Vitrine
6 m Gondola, 2. Section	Farm Life Farm Animals, Small pets; Wild Life Europe; Acces.; Plants/Trees; Showcase
6 m Gondole, 2. Section	Farm Life Animaux de la ferme, Animaux dom.; Wild Life Europe; Acces.; Plantes/Arbes; Vitrine
	09/2011

6.02



6.01 Gondel / Gondola / Gondole

6.02 Gondel / Gondola / Gondole

6.03



6 m Gondel, 3. Sektion	Schlümpfe; Farm Life Hunde; Wild Life; Wild Life Ocean; Urzeittiere
6 m Gondola, 3. Section	The Smurfs; Farm Life Dogs; Wild Life; Wild Life Ocean; Prehistoric animals
6 m Gondole, 3. Section	Les Schtroumpfs; Farm Life Chiens; Wild Life; Wild Life Ocean; Animaux préhistoriques
	09/2011

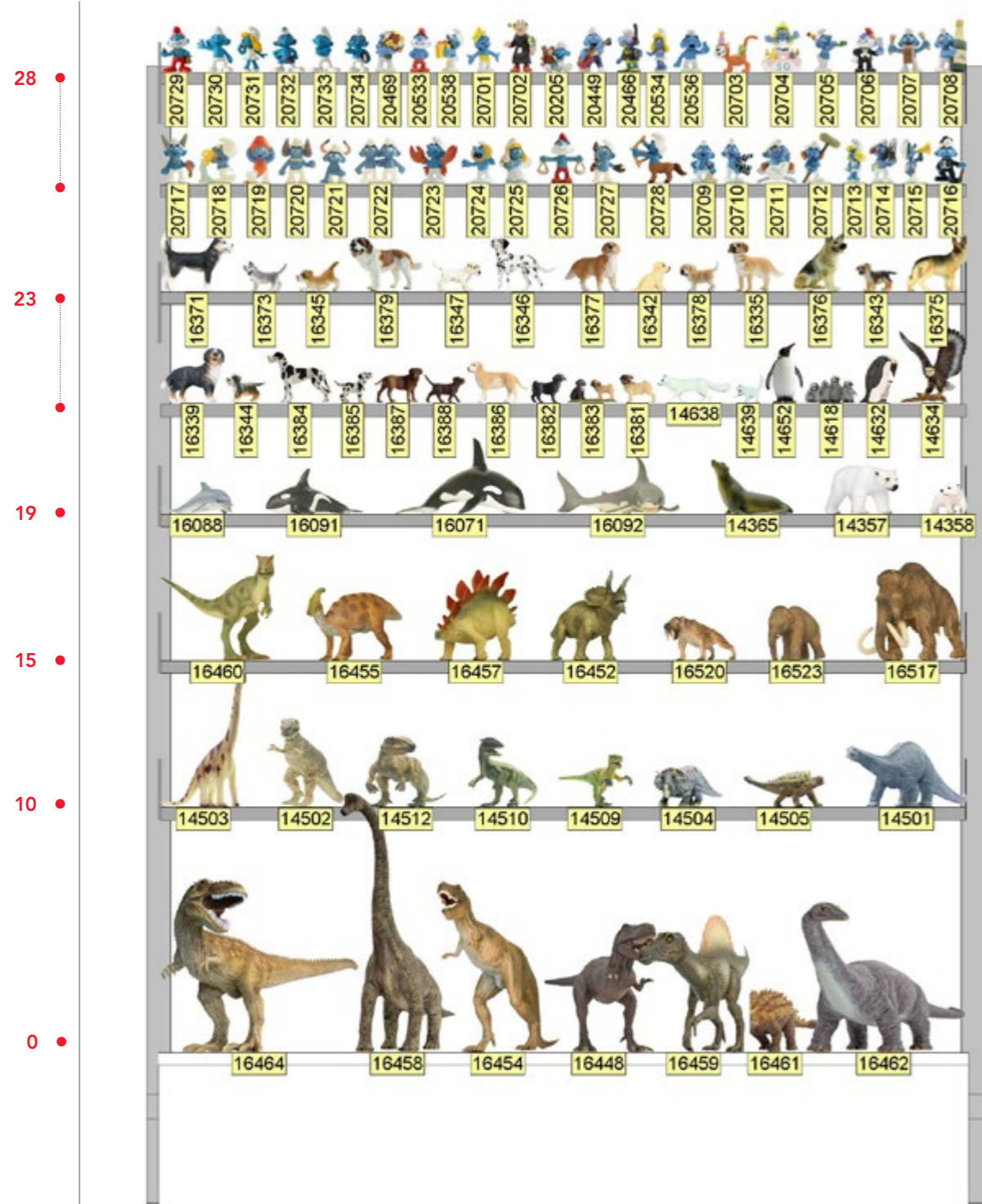

6 m Gondel, 4. Sektion	Ritterwelt; Helden; Bayala; Zubehör
6 m Gondola, 4. Section	The World of Knights; Heroes; Bayala; Accessories
6 m Gondole, 4. Section	Le Monde des Chevaliers; Héros; Bayala; Accessoires
	09/2011

6.04

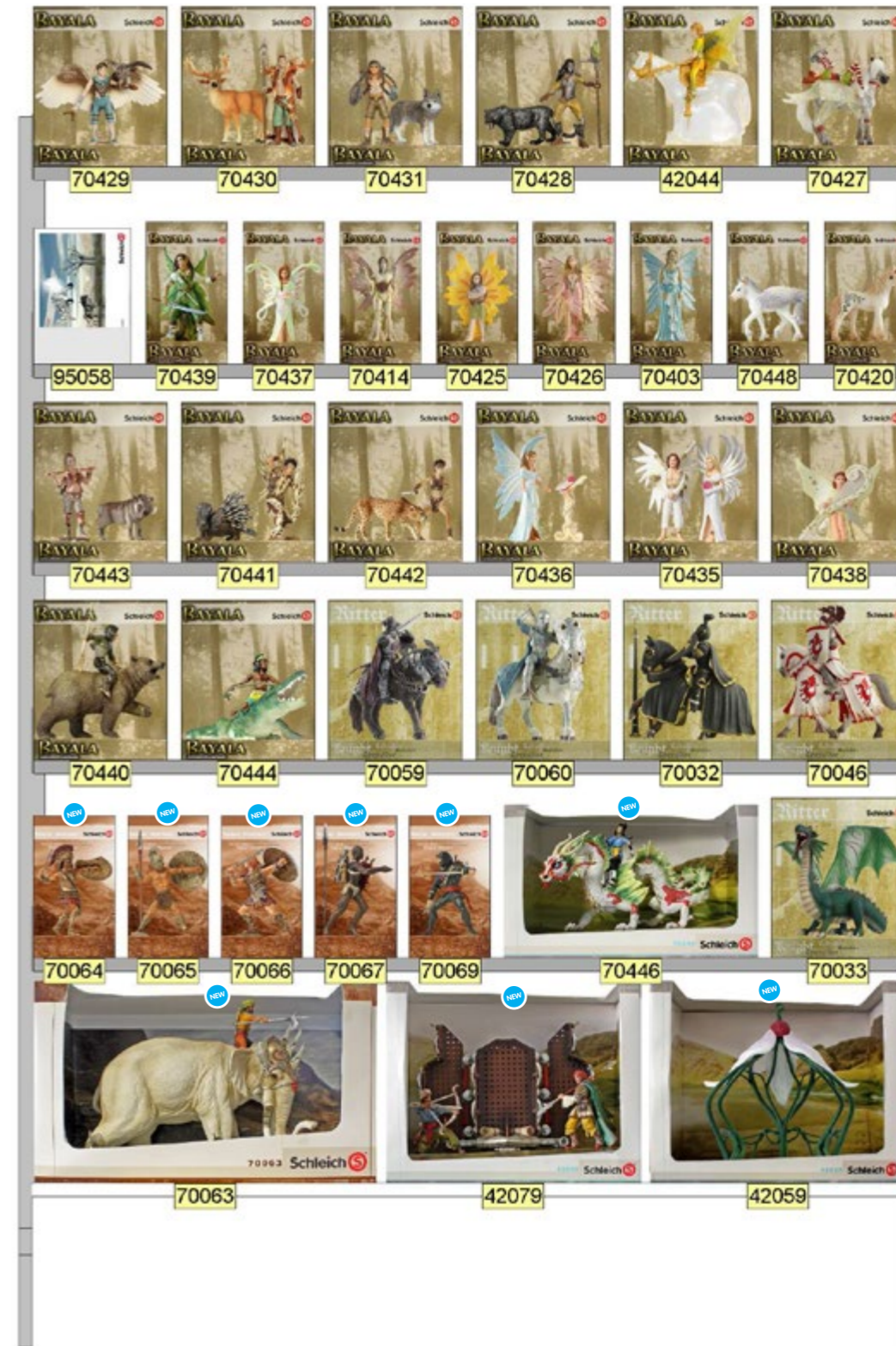
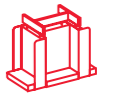

6.03 Gondel / Gondola / Gondole

6.04 Gondel / Gondola / Gondole

6.05



6 m Gondel, 5. Sektion	Bayala; Zubehör; Vitrine
6 m Gondola, 5. Section	Bayala; Accessories; Showcase
6 m Gondole, 5. Section	Bayala; Accessoires; Vitrine
	09/2011

28 ●

23 ●

20 ●

11 ●

0 ●

NEW

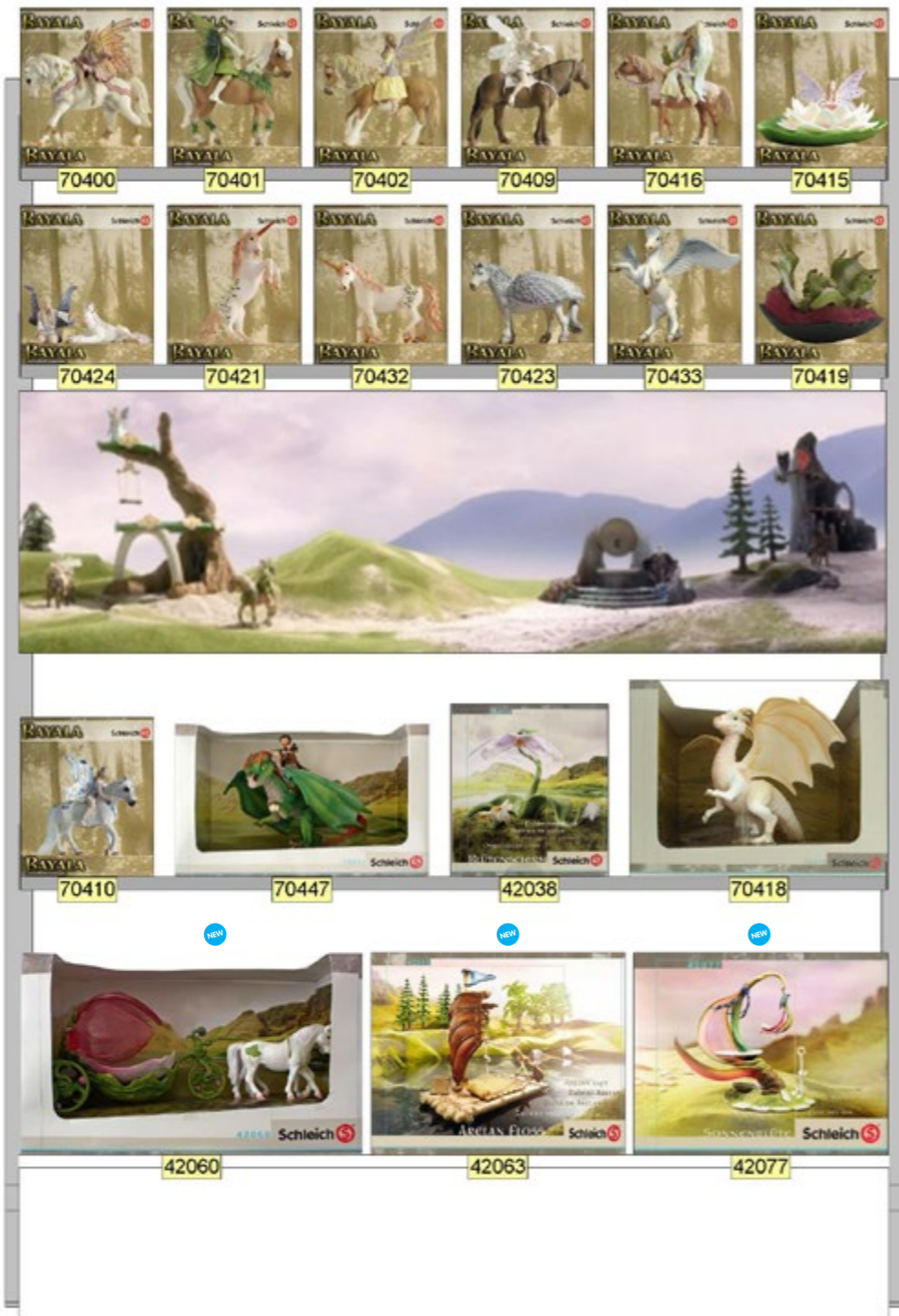

6 m Gondel, 6. Sektion	Wild Life; Zubehör
6 m Gondola, 6. Section	Wild Life; Accessories
6 m Gondole, 6. Section	Wild Life; Accessoires
	09/2011

6.06

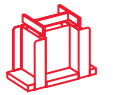

28 ●

23 ●

18 ●

14 ●

9 ●

0 ●

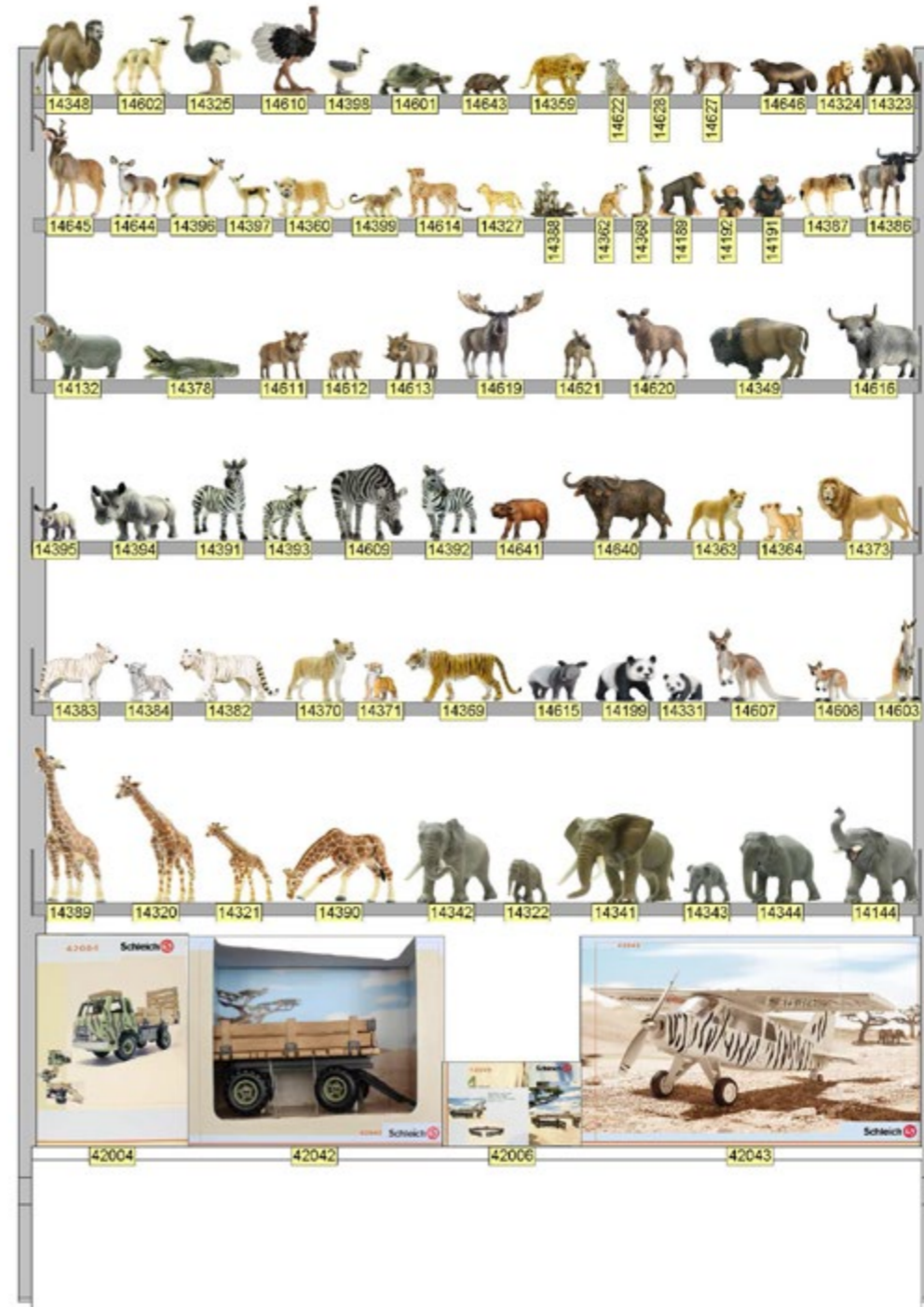

8.01



8 m Gondel, 1. Sektion	Farm Life Pferde; Wild Life Europa, Amerika; Menschen; Zubehör
8 m Gondola, 1. Section	Farm Life Horses; Wild Life Europe, America; People; Accessories
8 m Gondole, 1. Section	Farm Life Chevaux; Wild Life Europe, Amérique; Personnages; Accessoires
	09/2011

28
22
17
13
0

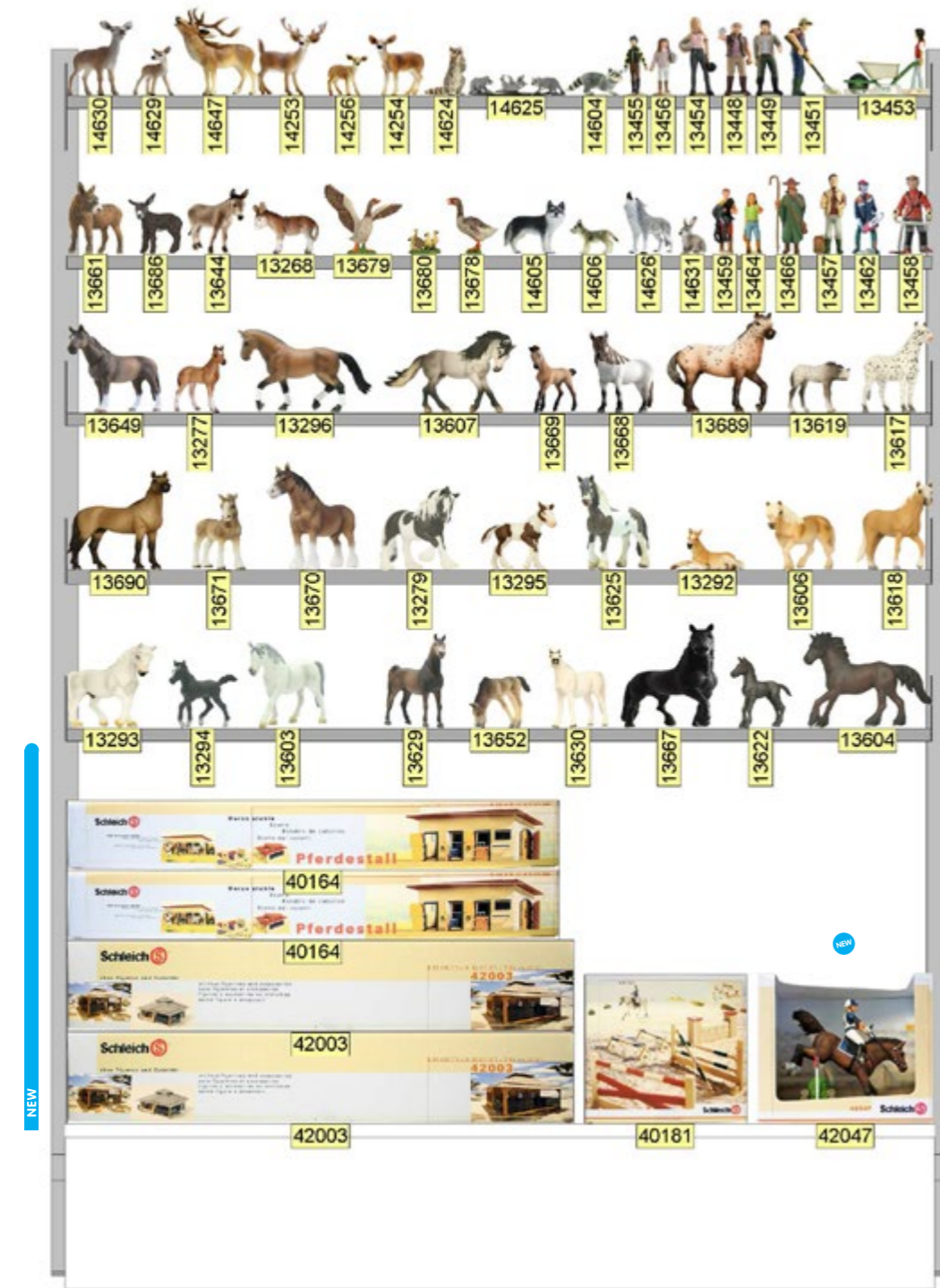

8 m Gondel, 2. Sektion	Farm Life Bauernhoftiere, Kleine Haustiere; Wild Life Europa; Zubehör; Vitrine
8 m Gondola, 2. Section	Farm Life Farm Animals, Small pets; Wild Life Europe; Accessories; Showcase
8 m Gondole, 2. Section	Farm Life Animaux de la ferme, Animaux dom.; Wild Life Europe; Accessoires; Vitrine
	09/2011

8.02



28
22
19
10
0



8.01 Gondel / Gondola / Gondole

8.02 Gondel / Gondola / Gondole

8.03



8 m Gondel, 3. Sektion	Farm Life Bauernhoftiere; Zubehör; Pflanzen/Bäume
8 m Gondola, 3. Section	Farm Life Farm Animals; Accessories; Plants/Trees
8 m Gondole, 3. Section	Farm Life Animaux de la ferme; Accessoires; Plantes/Arbes
	09/2011

28

22

17

10

0

NEW

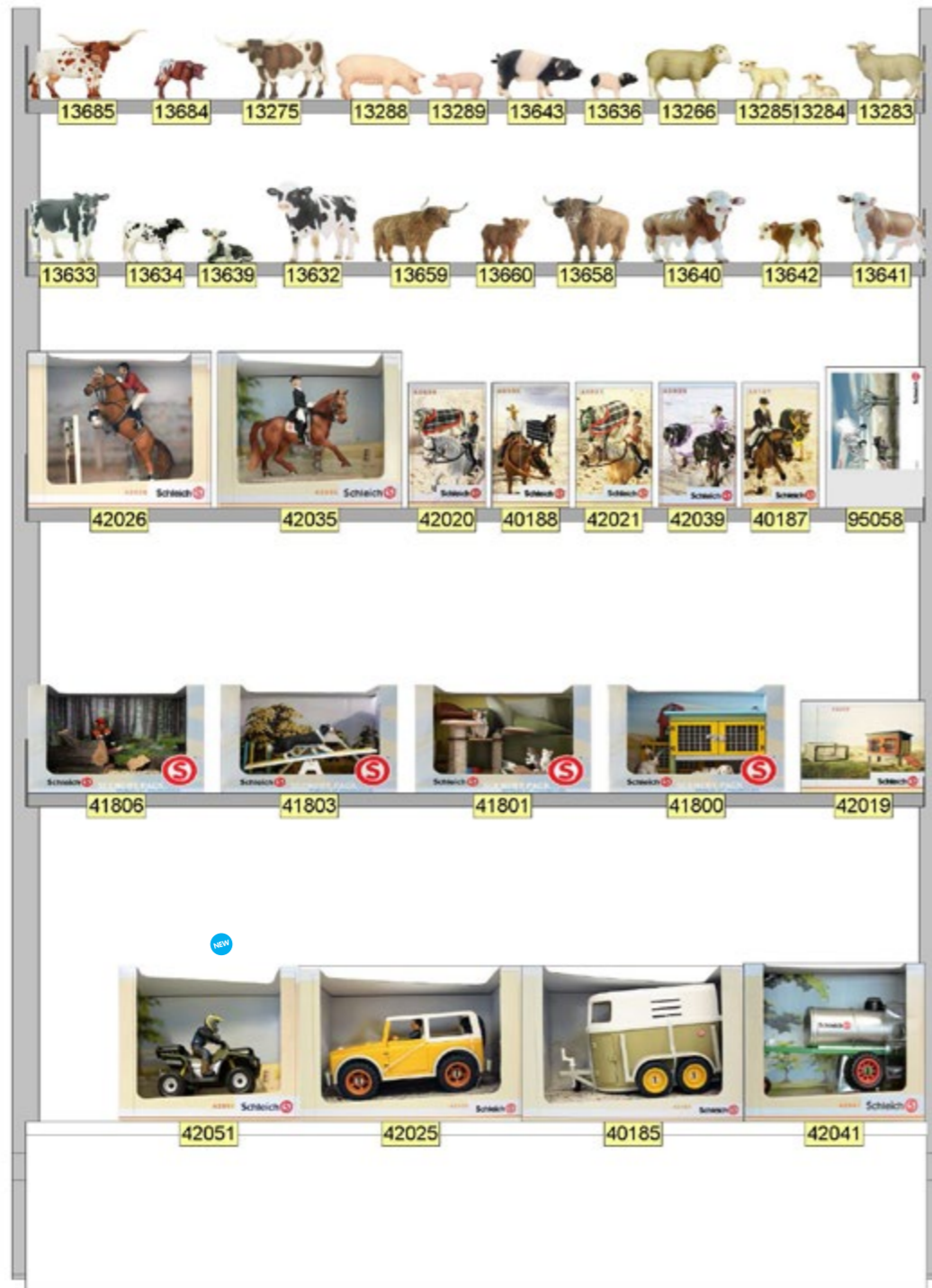

8 m Gondel, 4. Sektion	Farm Life Hunde; Wild Life; Wild Life Ocean; Urzeittiere
8 m Gondola, 4. Section	Farm Life Dogs; Wild Life; Wild Life Ocean; Prehistoric animals
8 m Gondole, 4. Section	Farm Life Chiens; Wild Life; Wild Life Ocean; Animaux préhistoriques
	09/2011

8.04



28

22

16

11

0

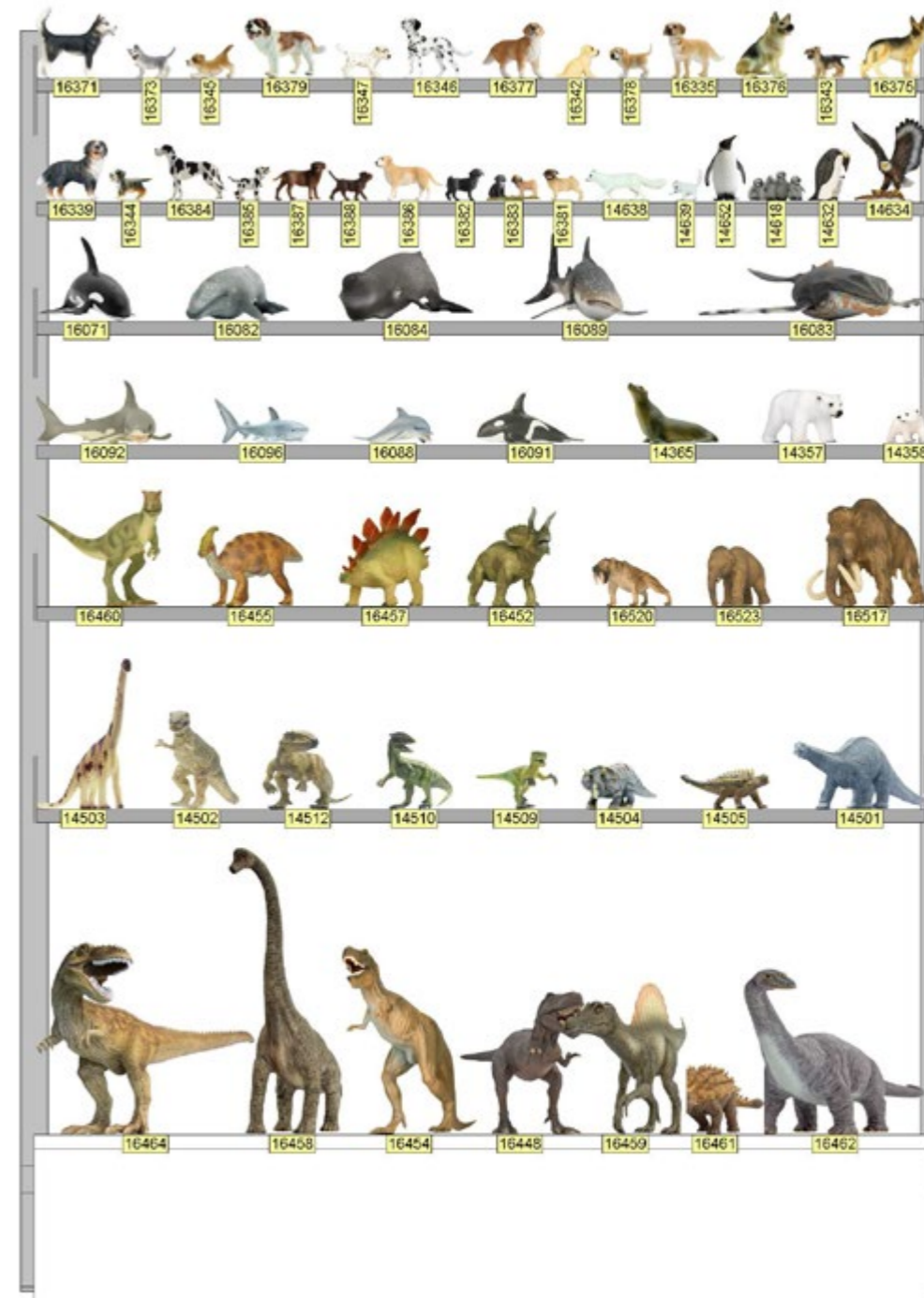

8.03 Gondel / Gondola / Gondole

8.04 Gondel / Gondola / Gondole

8.05



8 m Gondel, 5. Sektion	Schlümpfe; Bayala; Zubehör
8 m Gondola, 5. Section	The Smurfs; Bayala; Accessories
8 m Gondole, 5. Section	Les Schtroumpfs; Bayala; Accessoires
	09/2011

- 28 •
- 23 •
- 18 •
- 11 •
- 0 •

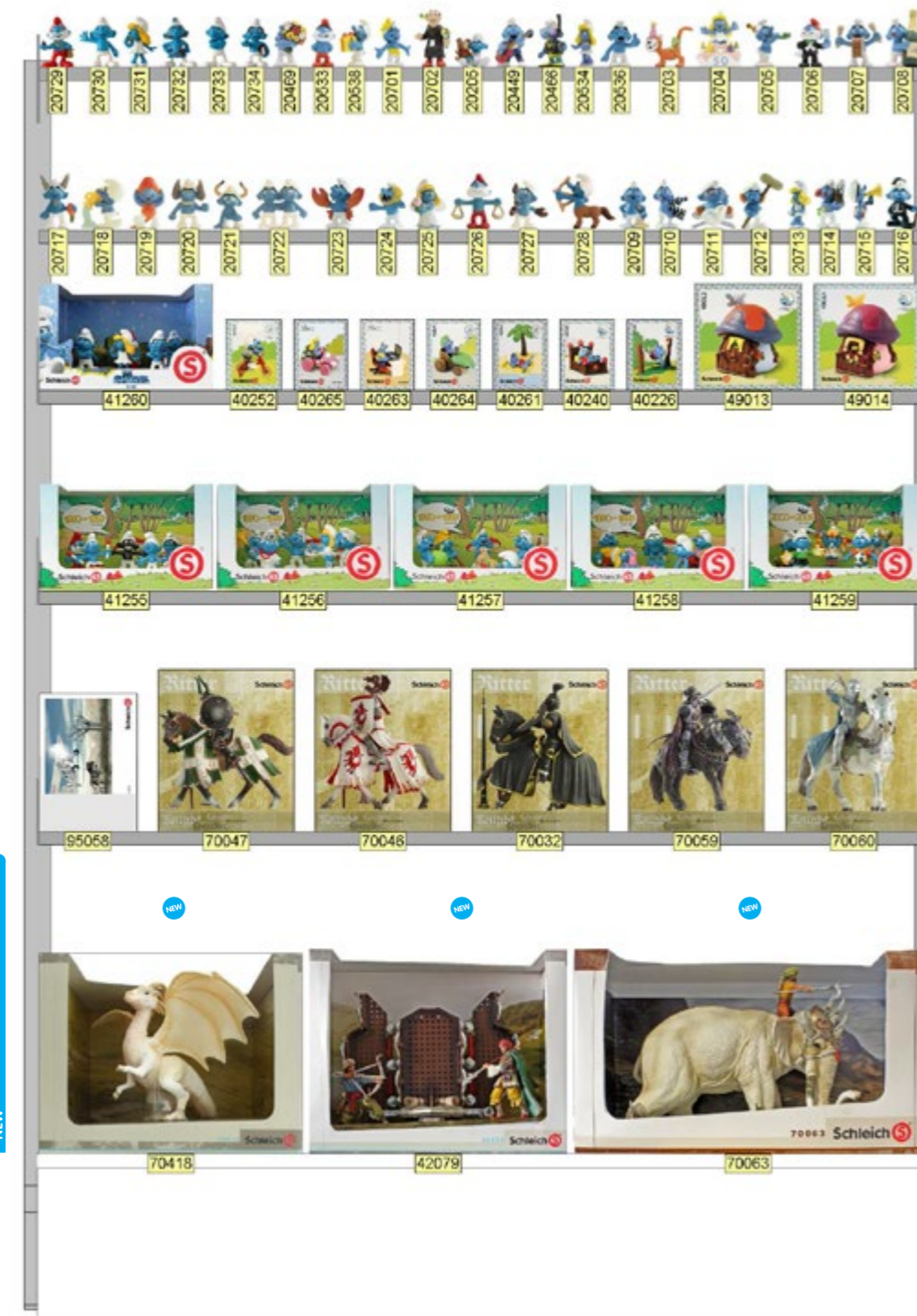

NEW

8 m Gondel, 6. Sektion	Bayala; Helden; Zubehör; Vitrine
8 m Gondola, 6. Section	Bayala; Heroes; Accessories; Showcase
8 m Gondole, 6. Section	Bayala; Héros; Accessoires; Vitrine
	09/2011

8.06



- 28 •
- 23 •
- 20 •
- 10 •
- 0 •

NEW

8.05 Gondel / Gondola / Gondole

8.06 Gondel / Gondola / Gondole

8.07



8 m Gondel, 7. Sektion	Bayala; Ritterwelt; Zubehör
8 m Gondola, 7. Section	Bayala; The World of Knights; Accessories
8 m Gondole, 7. Section	Bayala; Le Monde des Chevaliers; Accessoires
	09/2011

28 ●

24 ●

19 ●

14 ●

9 ●

0 ●

NEW



8 m Gondel, 8. Sektion	Wild Life; Zubehör
8 m Gondola, 8. Section	Wild Life; Accessories
8 m Gondole, 8. Section	Wild Life; Accessoires
	09/2011

8.08

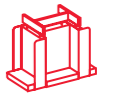

28 ●

23 ●

18 ●

14 ●

9 ●

0 ●

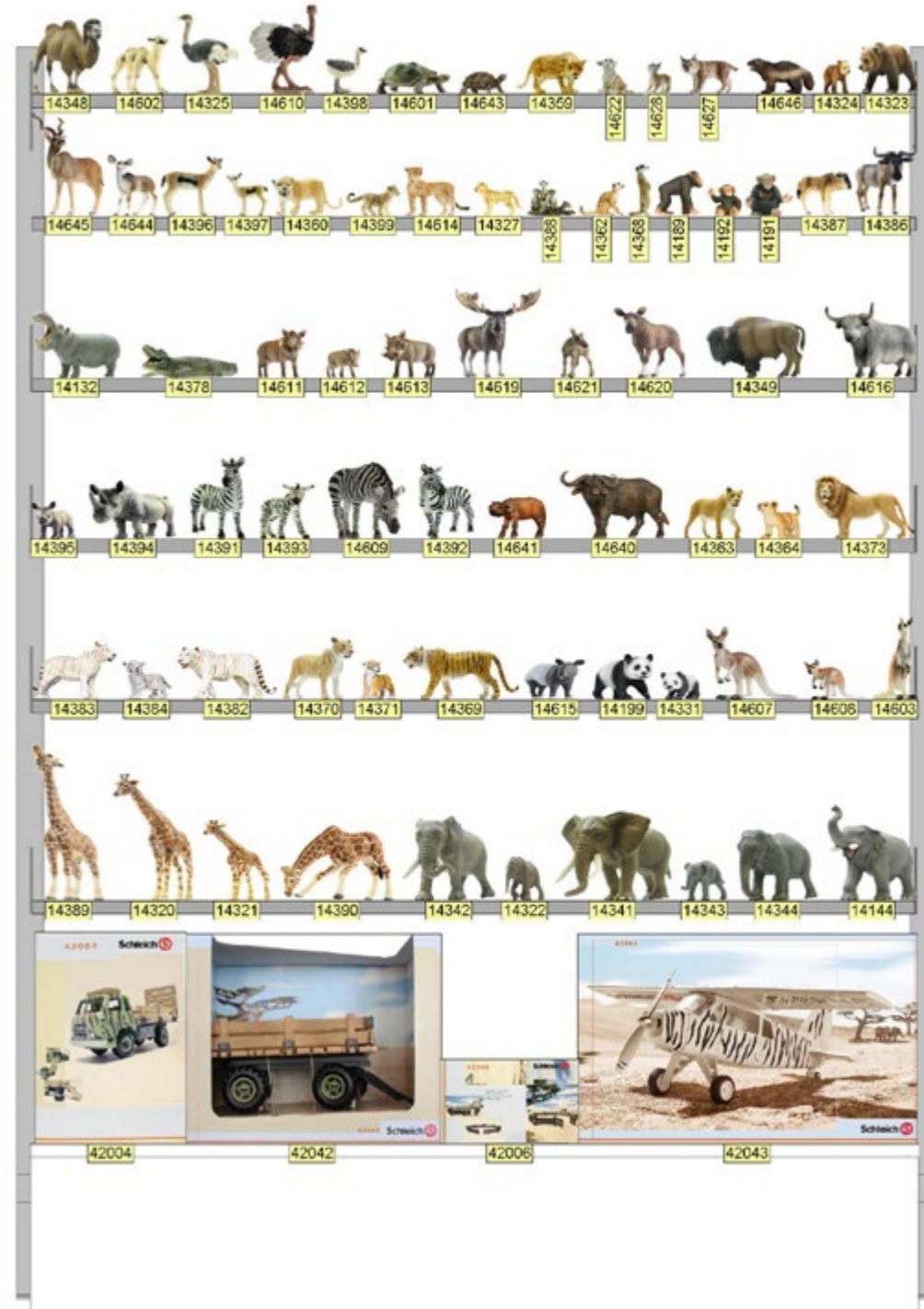

8.07 Gondel / Gondola / Gondole

8.08 Gondel / Gondola / Gondole

WAND MODULE
WALL MODULES
CLOISON MODULES

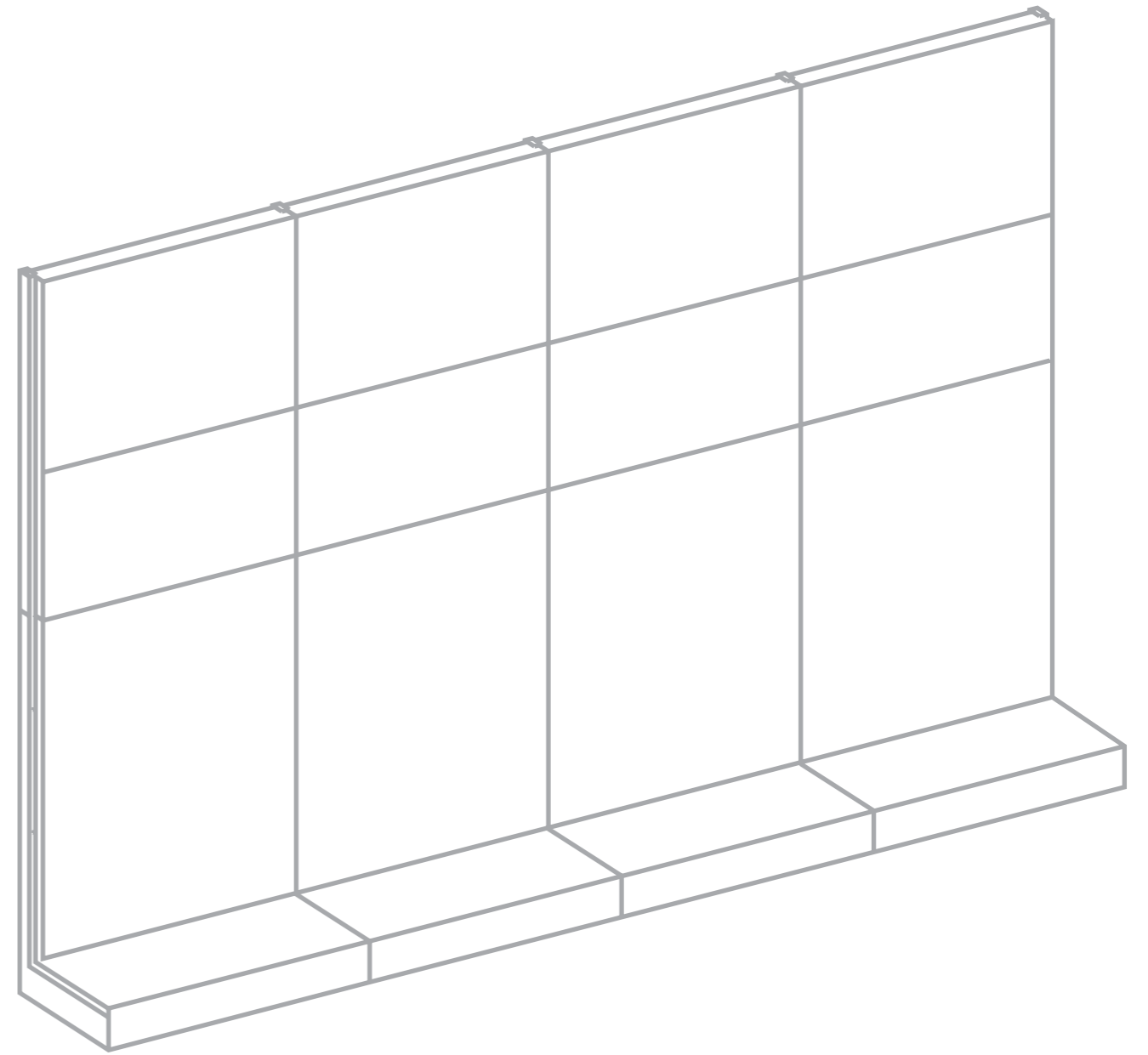

2.01

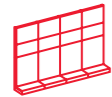

2 m Wand, 1. Sektion	Farm Life Bauernhoftiere, Pferde, Kleine Haustiere; Menschen; Zubehör
2 m Wall, 1. Section	Farm Life Farm Animals, Horses, Small pets; People; Accessories
2 m Cloison, 1. Section	Farm Life Animaux de la ferme, Chevaux, Animaux dom.; Personnages; Accessoires
	09/2011



2 m Wand, 2. Sektion	Farm Life Hunde; Wild Life; Urzeittiere; Zubehör
2 m Wall, 2. Section	Farm Life Dogs; Wild Life; Prehistoric animals; Accessories
2 m Cloison, 2. Section	Farm Life Chiens; Wild Life; Animaux préhistoriques; Accessoires
	09/2011

2.02

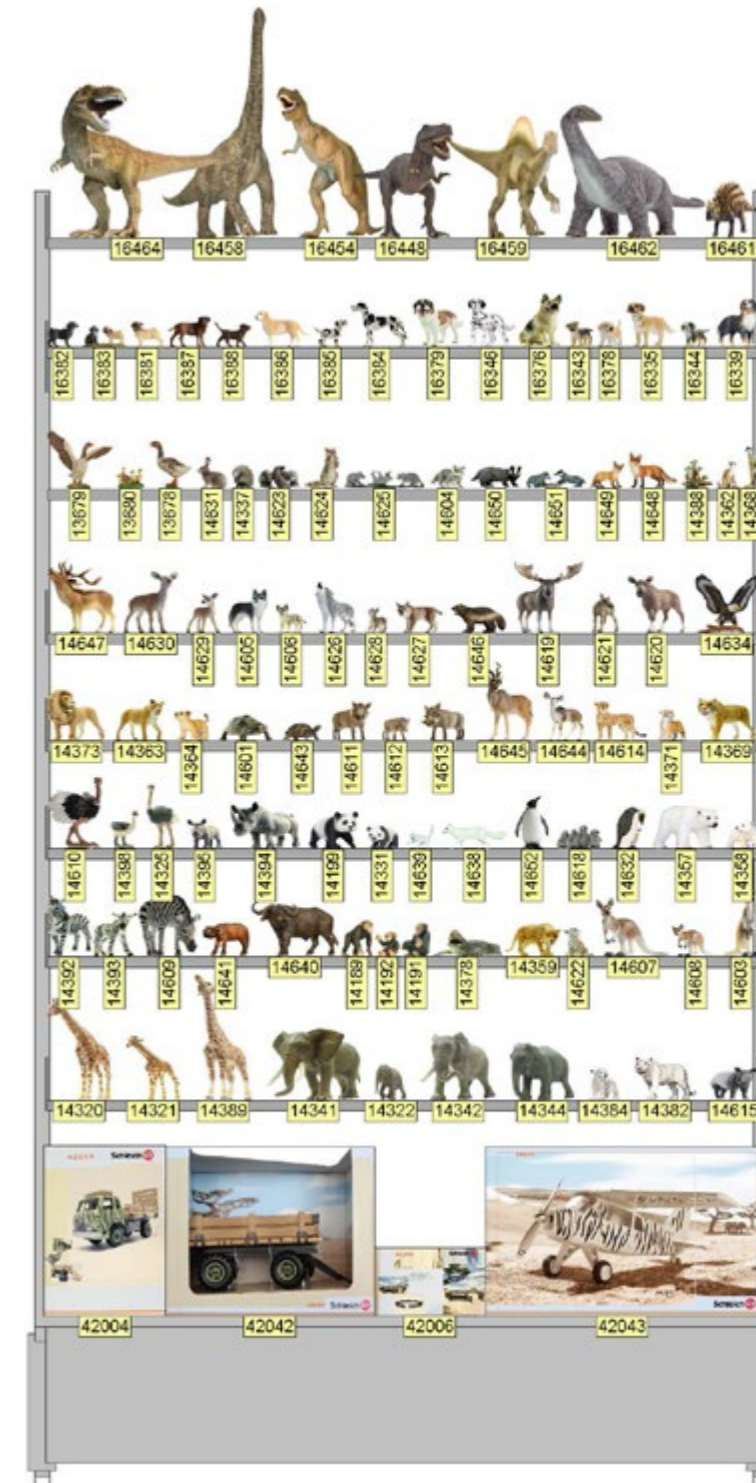
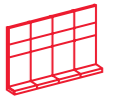

2.01 Wand / Wall / Cloison

2.02 Wand / Wall / Cloison

3.01

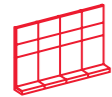

3 m Wand, 1. Sektion	Farm Life Bauernhoftiere, Pferde, Kleine Haustiere; Menschen; Zubehör
3 m Wall, 1. Section	Farm Life Farm Animals, Horses, Small pets; People; Accessories
3 m Cloison, 1. Section	Farm Life Animaux de la ferme, Chevaux, Animaux dom.; Personnages; Accessoires
	09/2011

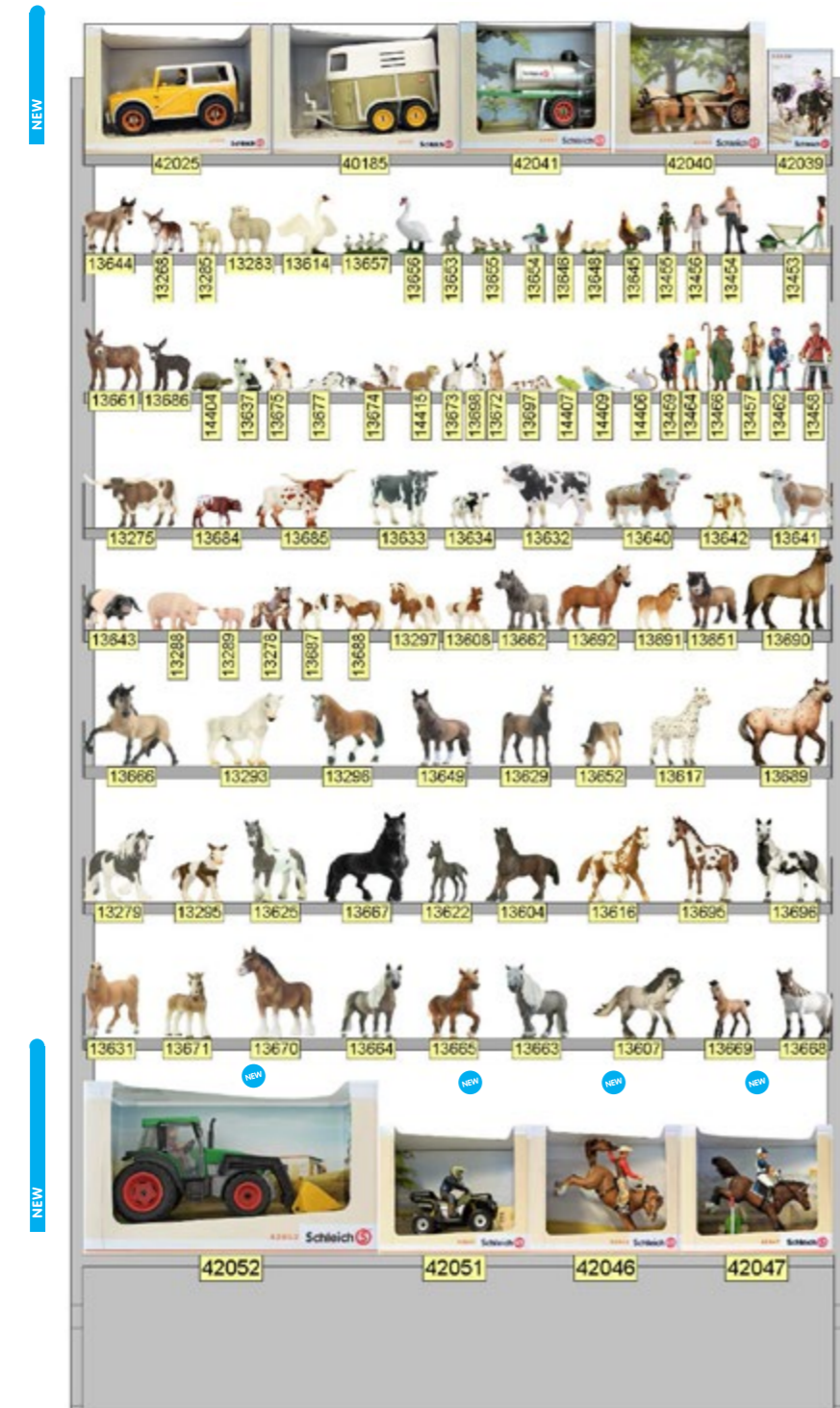

3 m Wand, 2. Sektion	Urzeittiere; Farm Life Hunde; Wild Life; Zubehör
3 m Wall, 2. Section	Prehistoric animals; Farm Life Dogs; Wild Life; Accessories
3 m Cloison, 2. Section	Animaux préhistoriques; Farm Life Chiens; Wild Life; Accessoires
	09/2011

3.02

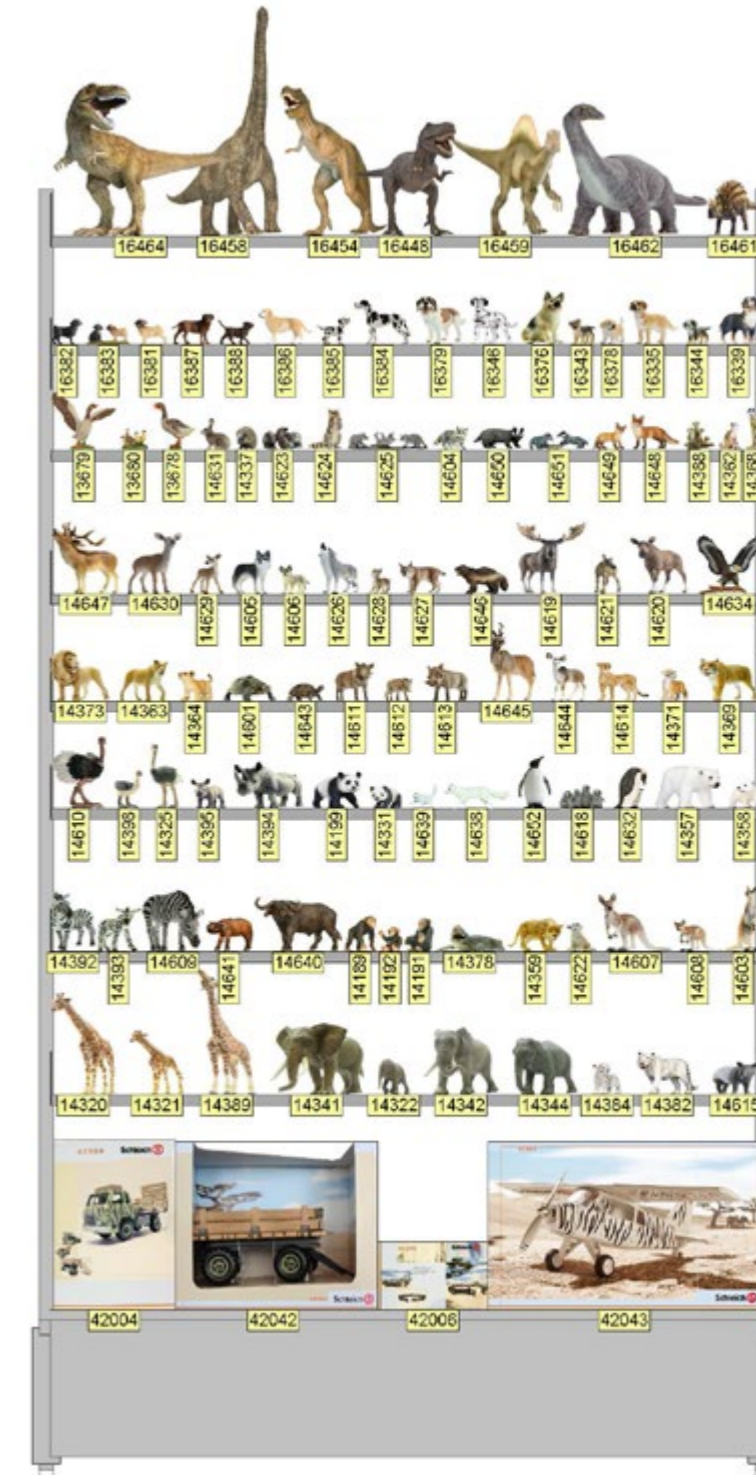

3.01 Wand / Wall / Cloison

3.02 Wand / Wall / Cloison

3.03

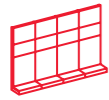

3.03 Wand / Wall / Cloison

3 m Wand, 3. Sektion	Bayala; Helden; Zubehör; Vitrine
3 m Wall, 3. Section	Bayala; Heroes; Accessories; Showcase
3 m Cloison, 3. Section	Bayala; Héroes; Accessoires; Vitrine
	09/2011

- 35 •
- 31 •
- 26 •
- 23 •
- 14 •
- 9 •
- 0 •

NEW

4.01

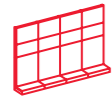

4 m Wand, 1. Sektion	Farm Life Bauernhoftiere, Pferde, Kleine Haustiere; Menschen; Zubehör
4 m Wall, 1. Section	Farm Life Farm Animals, Horses, Small pets; People; Accessories
4 m Cloison, 1. Section	Farm Life Animaux de la ferme, Chevaux, Animaux dom.; Personnages; Accessoires
	09/2011

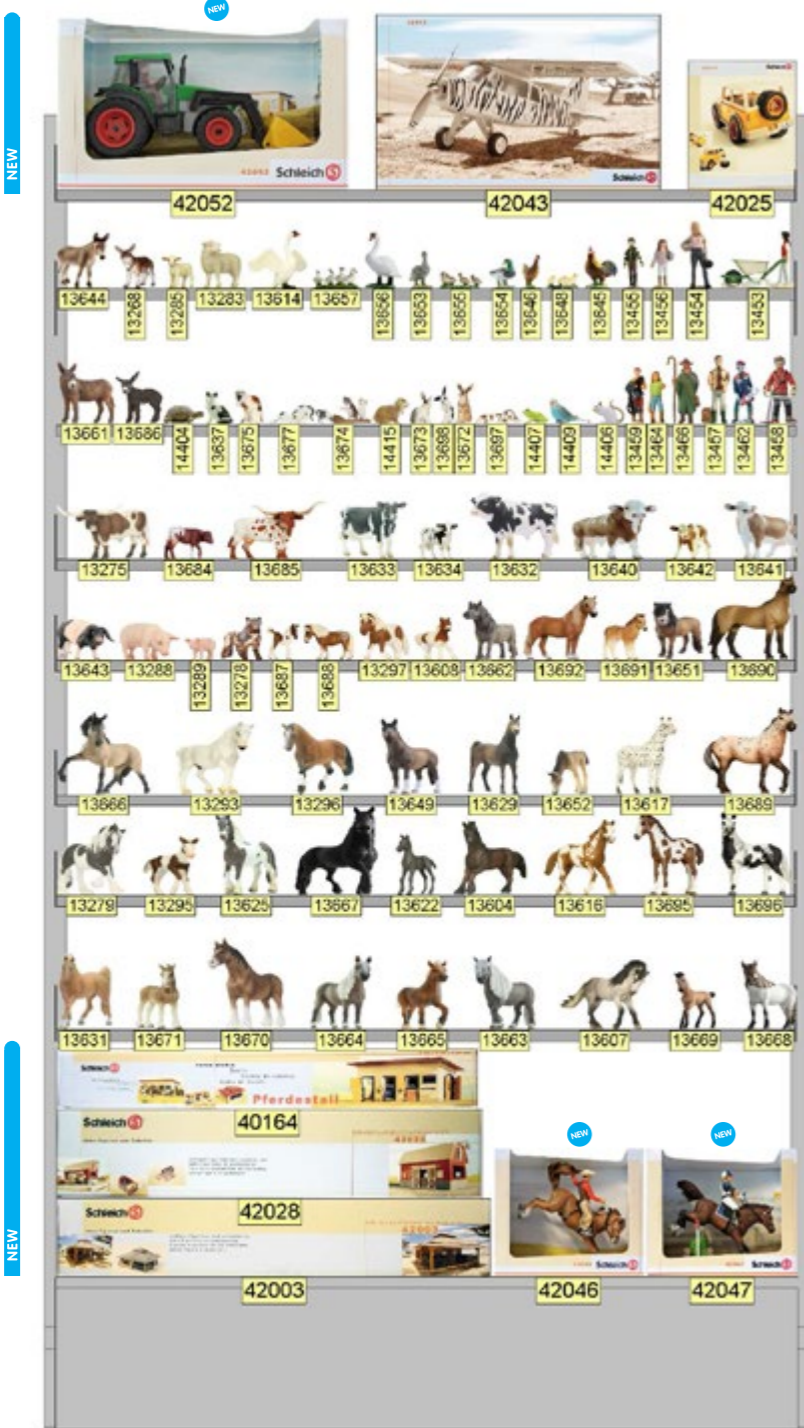

4 m Wand, 2. Sektion	Farm Life Hunde; Wild Life; Pflanzen/Bäume; Zubehör
4 m Wall, 2. Section,	Farm Life Dogs; Wild Life; Plants/Trees; Accessories
4 m Cloison, 2. Section	Farm Life Chiens; Wild Life; Plantes/Arbes; Accessoires
	09/2011

4.02

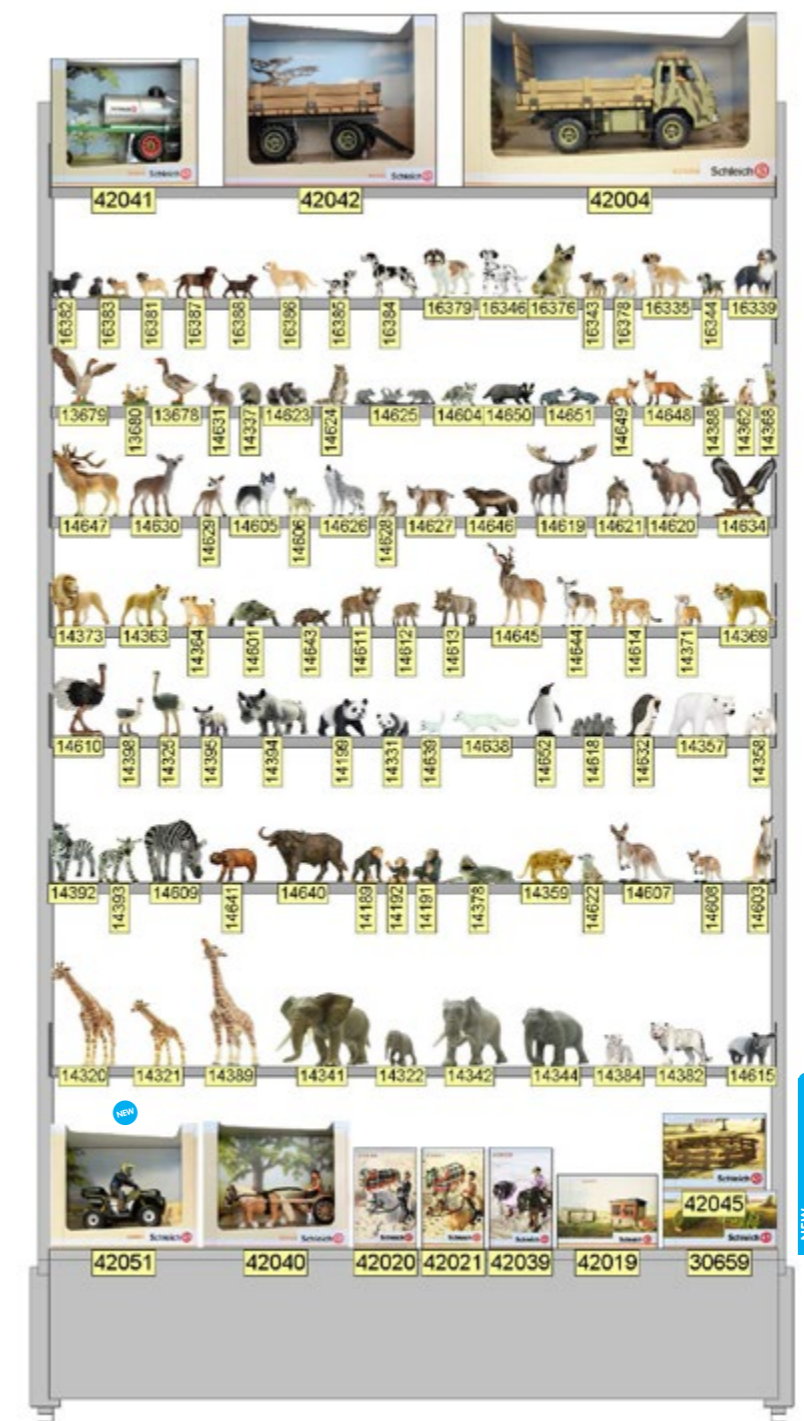
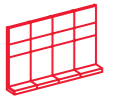

4.01 Wand / Wall / Cloison

4.02 Wand / Wall / Cloison

4.03

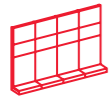

4 m Wand, 3. Sektion	Bayala; Helden; Zubehör; Vitrine
4 m Wall, 3. Section	Bayala; Heroes; Accessoires; Showcase
4 m Cloison, 3. Section	Bayala; Héroes; Accessoires; Vitrine
	09/2011

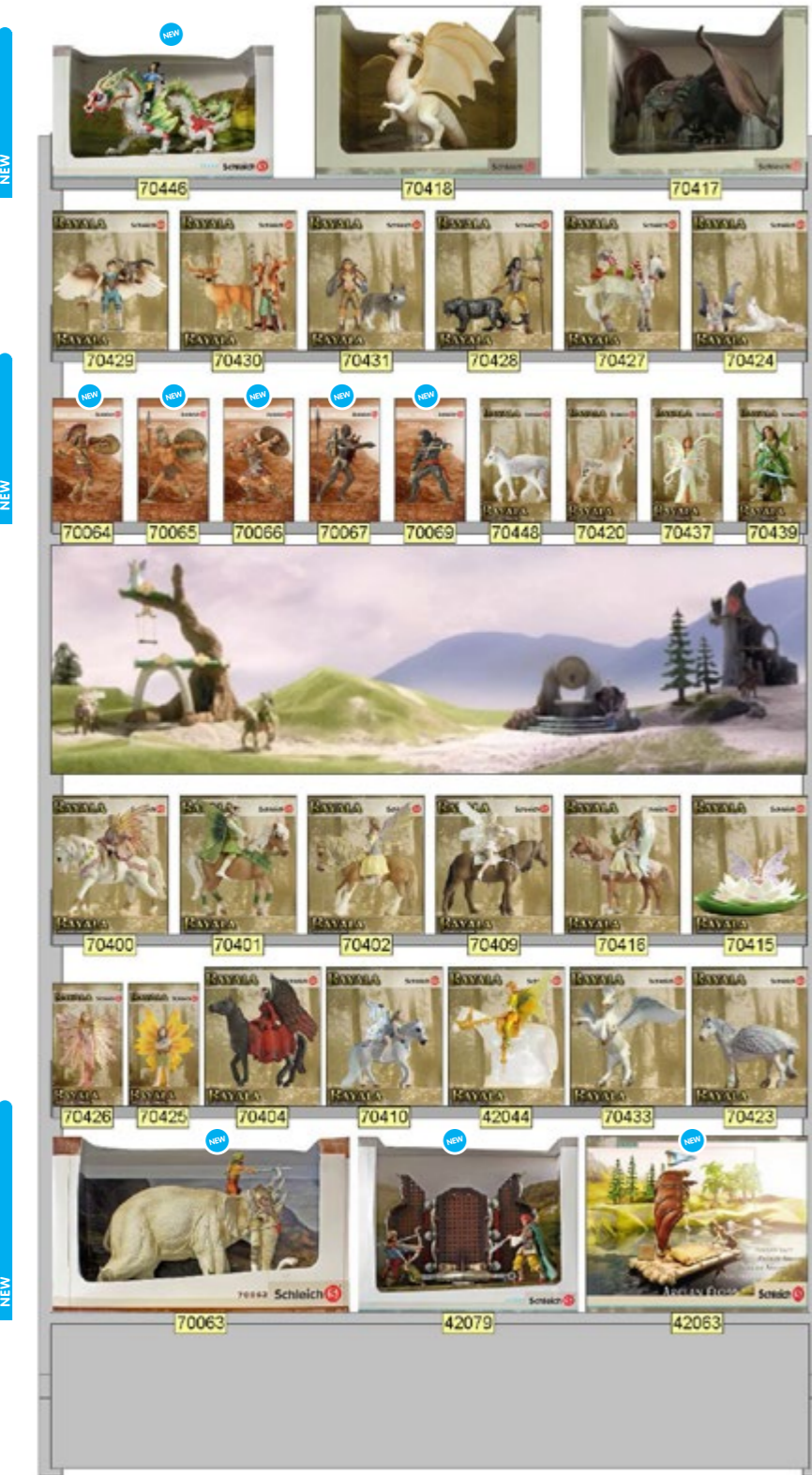

4 m Wand, 4. Sektion	Ritterwelt; Bayala; Zubehör; Urzeittiere
4 m Wall, 4. Section	The World of Knights; Bayala; Accessories; Prehistoric animals
4 m Cloison, 4. Section	Le Monde des Chevaliers; Bayala; Accessoires; Animeaux préhistoriques
	09/2011

4.04

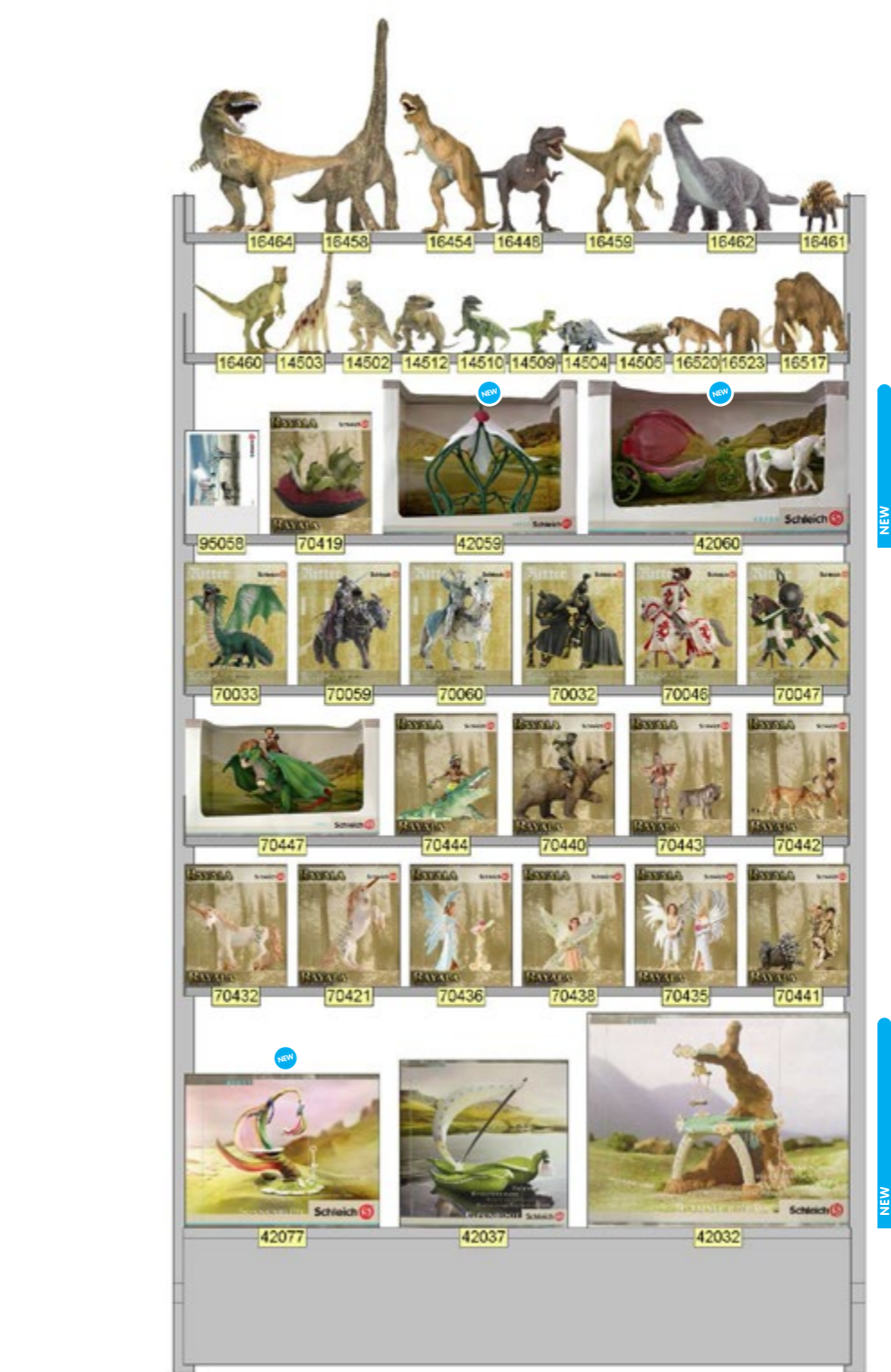

4.03 Wand / Wall / Cloison

4.04 Wand / Wall / Cloison

5.01



5 m Wand, 1. Sektion	Farm Life Bauernhoftiere, Pferde, Kleine Haustiere; Menschen; Zubehör
5 m Wall, 1. Section	Farm Life Farm Animals, Horses, Small pets; People; Accessories
5 m Cloison, 1. Section	Farm Life Animaux de la ferme, Chevaux, Animaux dom.; Personnages; Accessoires
09/2011	



- 35 •
- 31 •
- 27 •
- 23 •
- 19 •
- 15 •
- 10 •
- 0 •

5.02

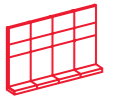

5 m Wand, 2. Sektion	Farm Life Hunde, Pferde; Wild Life; Zubehör
5 m Wall, 2. Section	Farm Life Dogs, Horses; Wild Life; Accessories
5 m Cloison, 2. Section	Farm Life Chiens, Chevaux; Wild Life; Accessoires
09/2011	

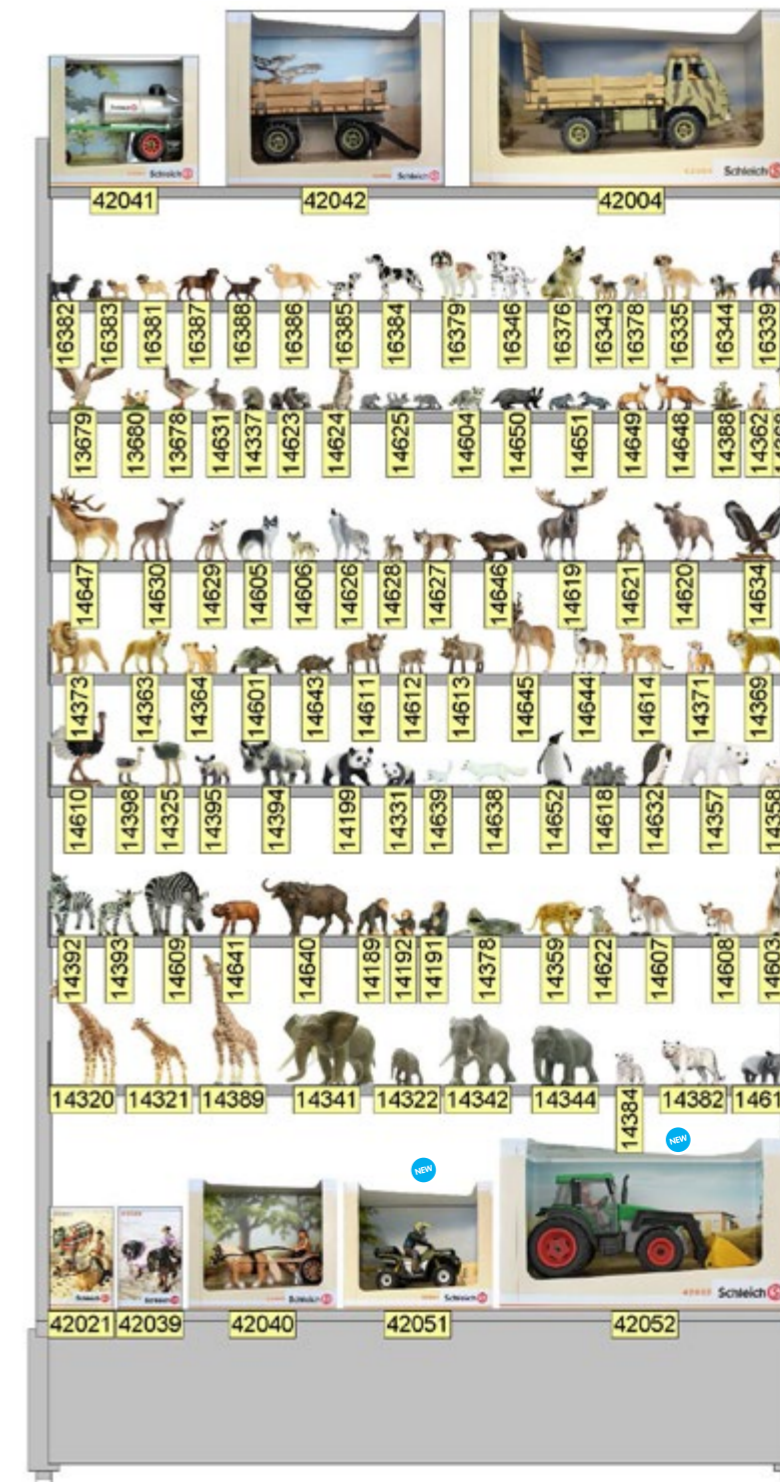

- 35 •
- 31 •
- 27 •
- 23 •
- 19 •
- 15 •
- 10 •
- 0 •

5.03



5 m Wand, 3. Sektion	Urzeittiere; Wild Life Ocean; Schlümpfe; Wild Life Zubehör
5 m Wall, 3. Section	Prehistoric animals ; Wild Life Ocean; Smurfs; Wild Life Accessories
5 m Cloison, 3. Section	Animaux préhistoriques ; Wild Life Ocean; Schtroumpfs; Wild Life Accessoires
	09/2011

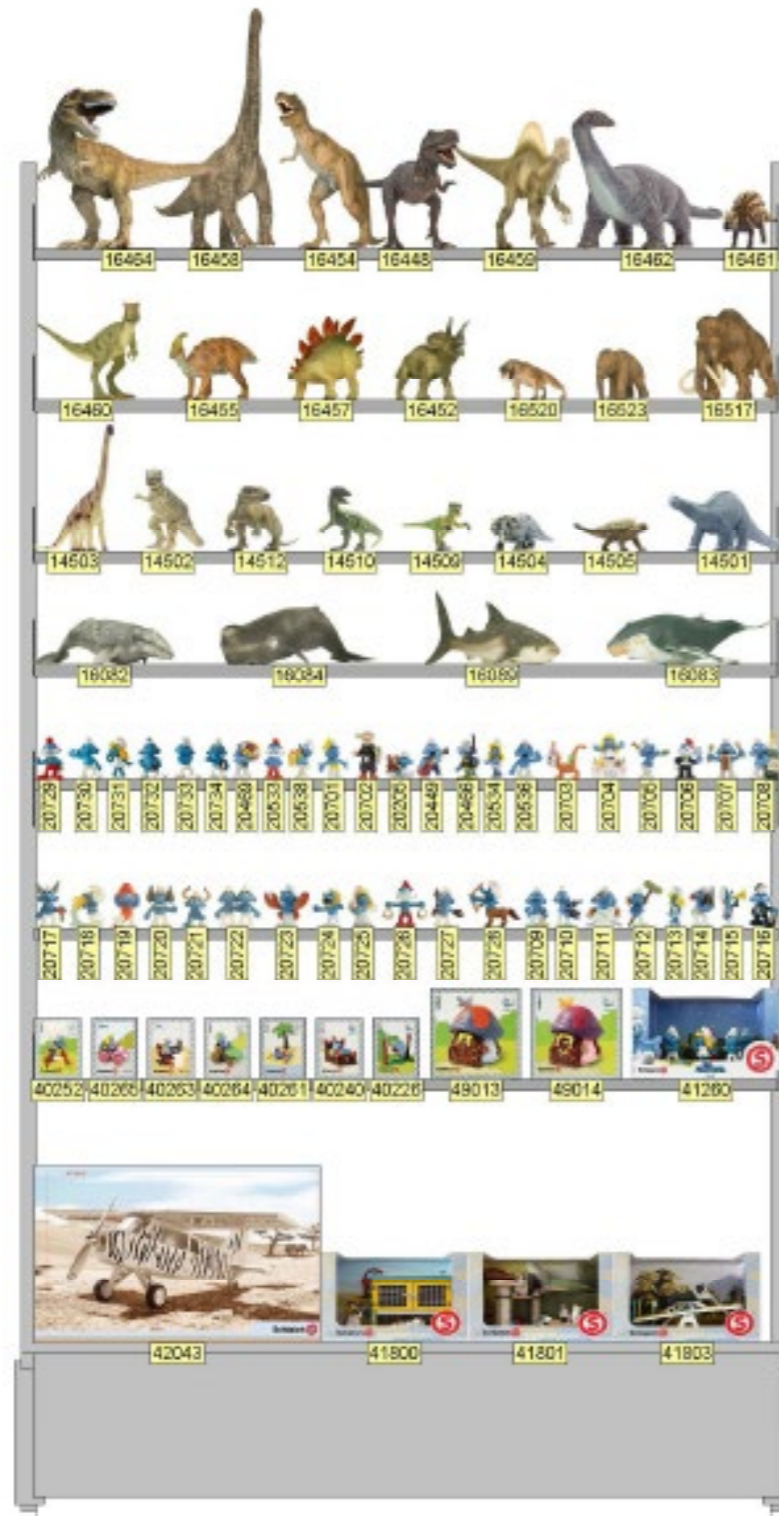

5.03 Wand / Wall / Cloison

5 m Wand, 4. Sektion	Bayala; Zubehör; Vitrine
5 m Wall, 4. Section	Bayala; Accessories; Showcase
5 m Cloison, 4. Section	Bayala; Accessoires; Vitrine
	09/2011

5.04

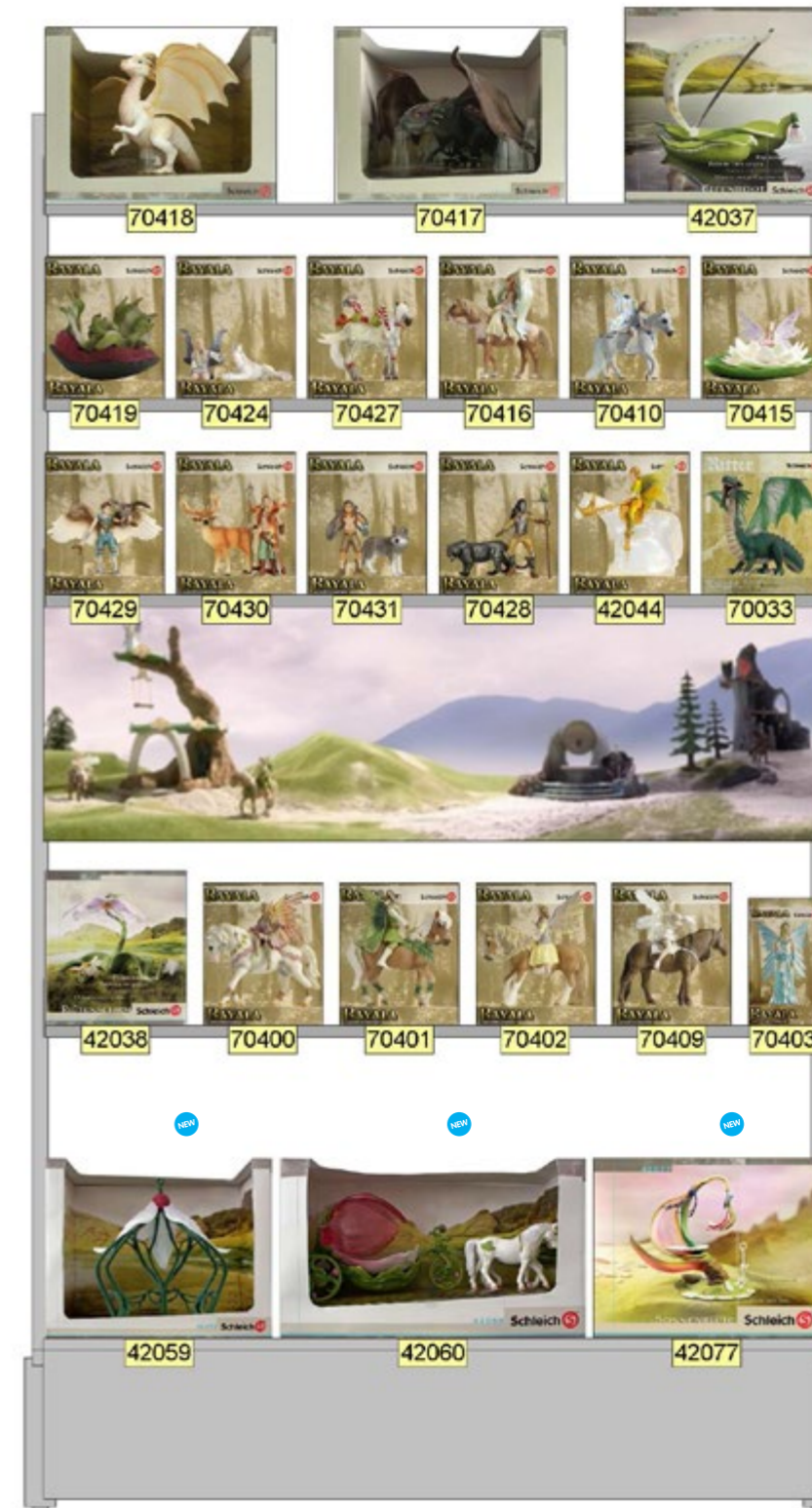
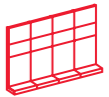

5.04 Wand / Wall / Cloison

NEW

5.05

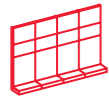

5.05 Wand / Wall / Cloison

5 m Wand, 5. Sektion	Bayala; Helden; Zubehör
5 m Wall, 5. Section	Bayala; Heroes; Accessories
5 m Cloison, 5. Section	Bayala; Héroes; Accessoires
	09/2011

- 35 •
- 30 •
- 25 •
- 21 •
- 15 •
- 10 •
- 0 •

NEW



NEW



NEW



NEW



NEW



NEW



NEW



6.01

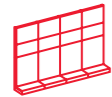

6 m Wand, 1. Sektion	Farm Life Pferde, Kl. Haustiere; Wild Life Europa, Amerika; Menschen; Zubehör
6 m Wall, 1. Section	Farm Life Horses, Small pets; Wild Life Europe, America; People; Accessories
6 m Cloison, 1. Section	Farm Life Chevaux, Animaux dom.; Wild Life Europe, Amérique; Personnages; Acces.
	09/2011

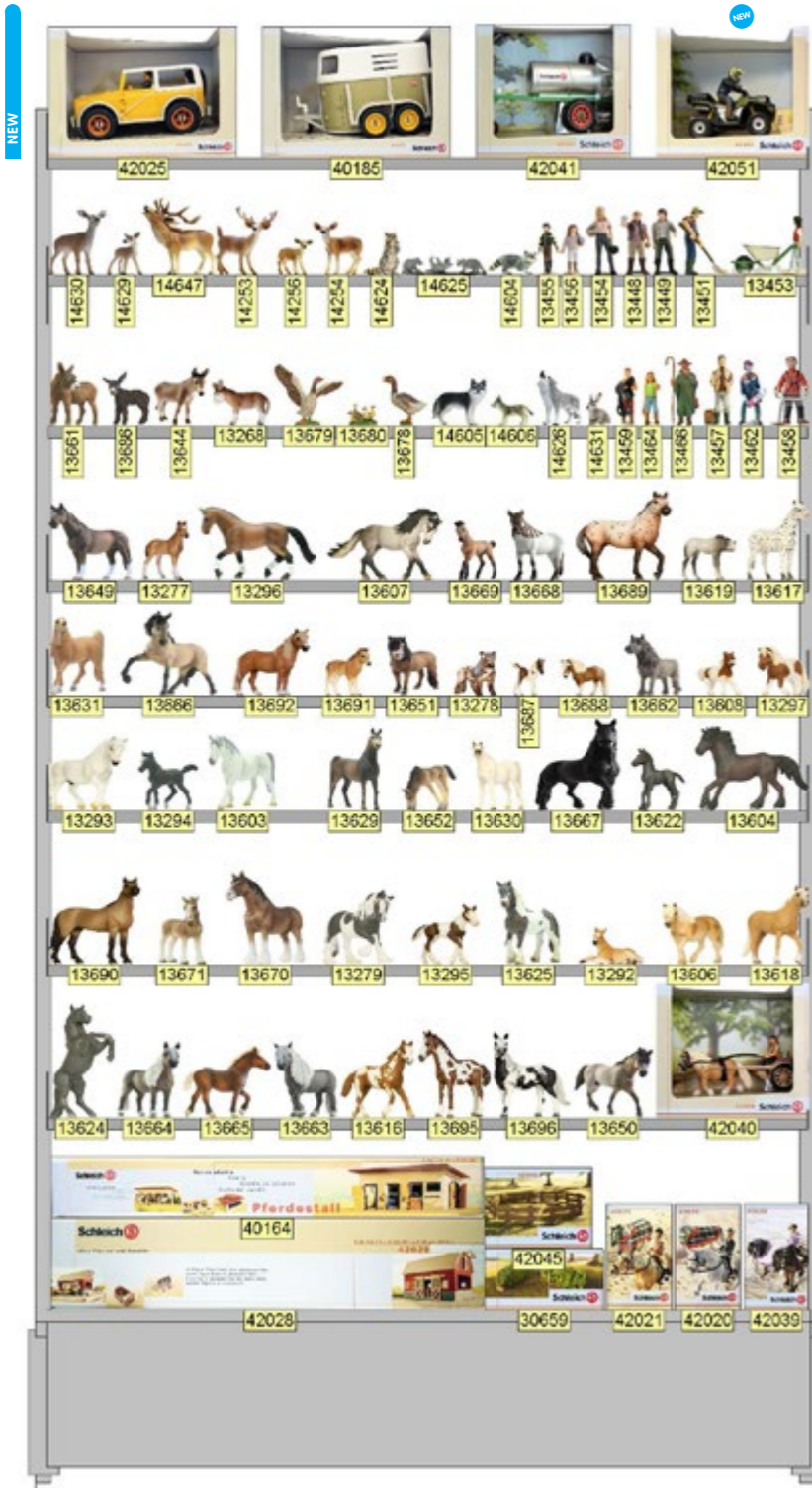

6.02

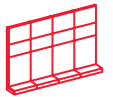

6 m Wand, 2. Sektion	Farm Life Bauernhoftiere, Kleine Haustiere; Wild Life; Zubehör
6 m Wall, 2. Section	Farm Life Farm Animals, Small pets; Wild Life; Accessories
6 m Cloison, 2. Section	Farm Life Animaux de la ferme, Animaux domestiques; Wild Life; Accessoires
	09/2011

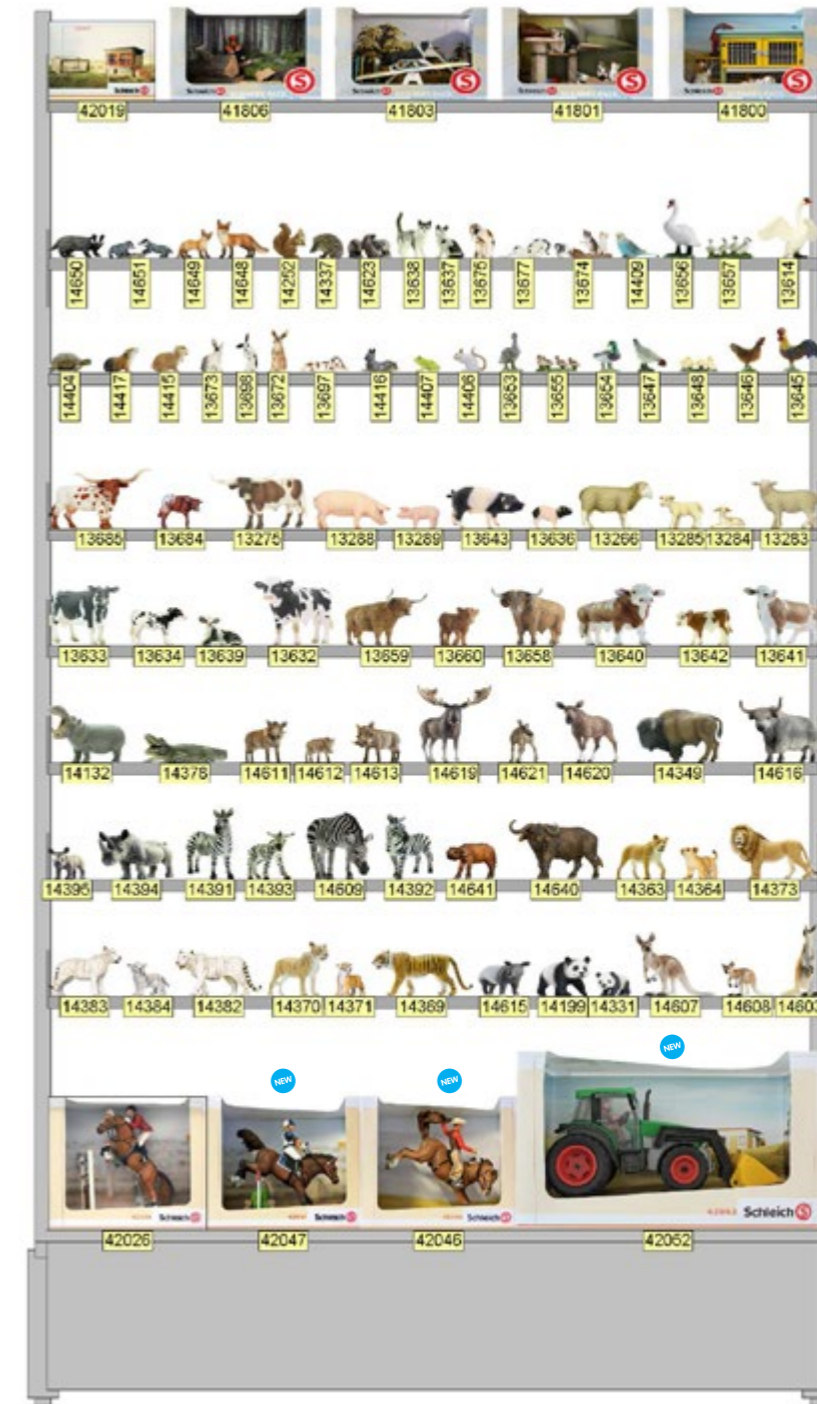

6.01 Wand / Wall / Cloison

6.02 Wand / Wall / Cloison

6.03



6 m Wand, 3. Sektion	Farm Life Hunde; Wild Life; Zubehör; Urzeittiere; Vitrine
6 m Wall, 3. Section	Farm Life Dogs; Wild Life; Accessories; Prehistoric animals; Showcase
6 m Cloison, 3. Section	Farm Life Chiens; Wild Life; Accessoires; Animaux préhistoriques; Vitrine
	09/2011

- 35 •
- 31 •
- 26 •
- 22 •
- 14 •
- 10 •
- 0 •

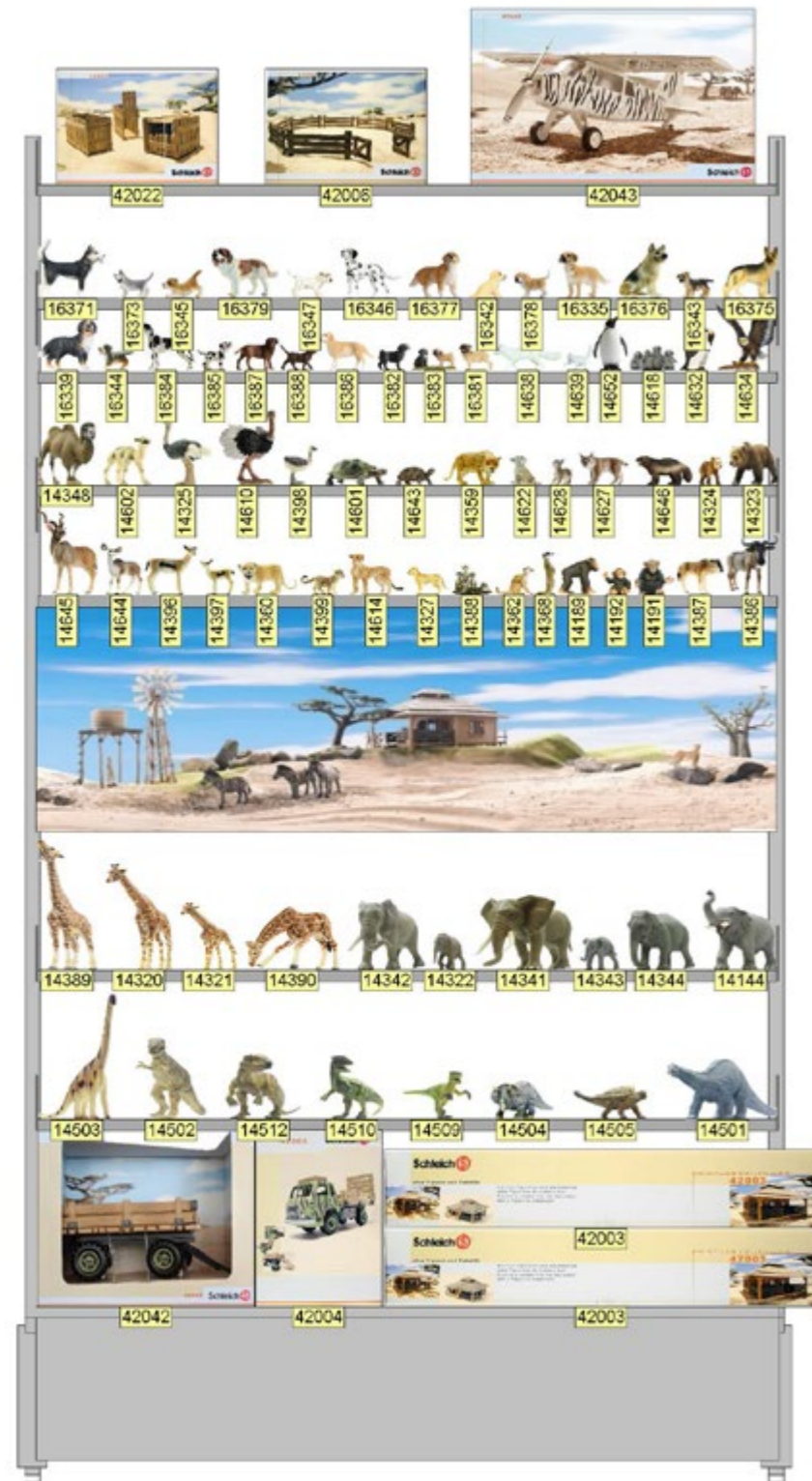

6 m Wand, 4. Sektion	Bayala; Ritterwelt; Helden; Urzeittiere; Zubehör
6 m Wall, 4. Section	Bayala; The World of Knights; Heroes; Prehistoric animals; Accessories
6 m Cloison, 4. Section	Bayala; Le Monde des Chevaliers; Héroes; Animaux préhistoriques; Accessoires
	09/2011

6.04



- 35 •
- 31 •
- 26 •
- 21 •
- 16 •
- 10 •
- 0 •

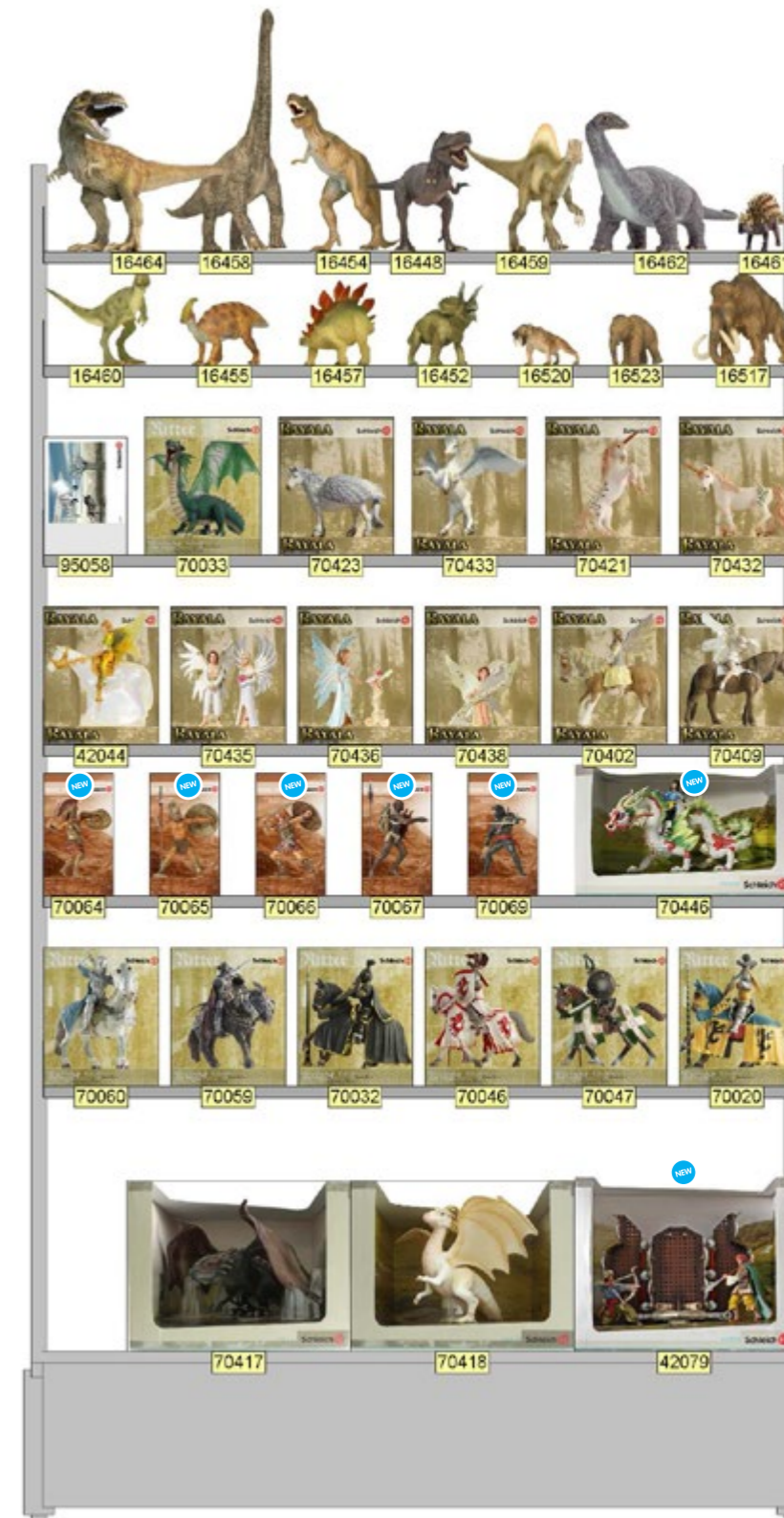

6.05



6 m Wand, 5. Sektion	Bayala; Vitrine
6 m Wall, 5. Section	Bayala; Showcase
6 m Cloison, 5. Section	Bayala; Vitrine
	09/2011

- 35 •
- 30 •
- 26 •
- 23 •
- 14 •
- 9 •
- 0 •

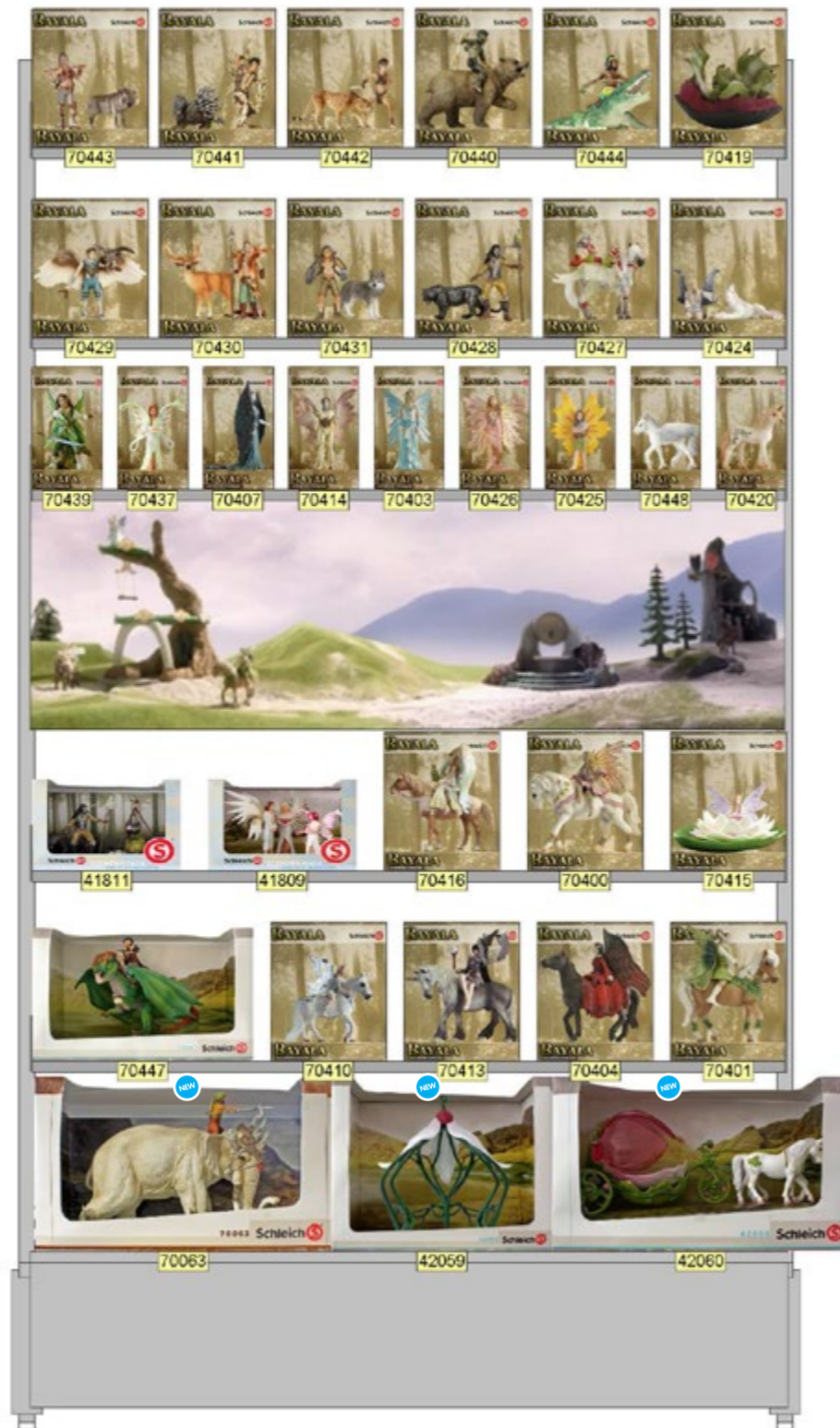

6 m Wand, 6. Sektion	Pflanzen/Bäume; Schlümpfe; Bayala Zubehör
6 m Wall, 6. Section	Plants/Trees; The Smurfs; Bayala Accessories
6 m Cloison, 6. Section	Plantes/Arbes; Les Schtroumpfs; Bayala Accessoires
	09/2011

6.06



- 35 •
- 30 •
- 24 •
- 20 •
- 15 •
- 11 •
- 0 •

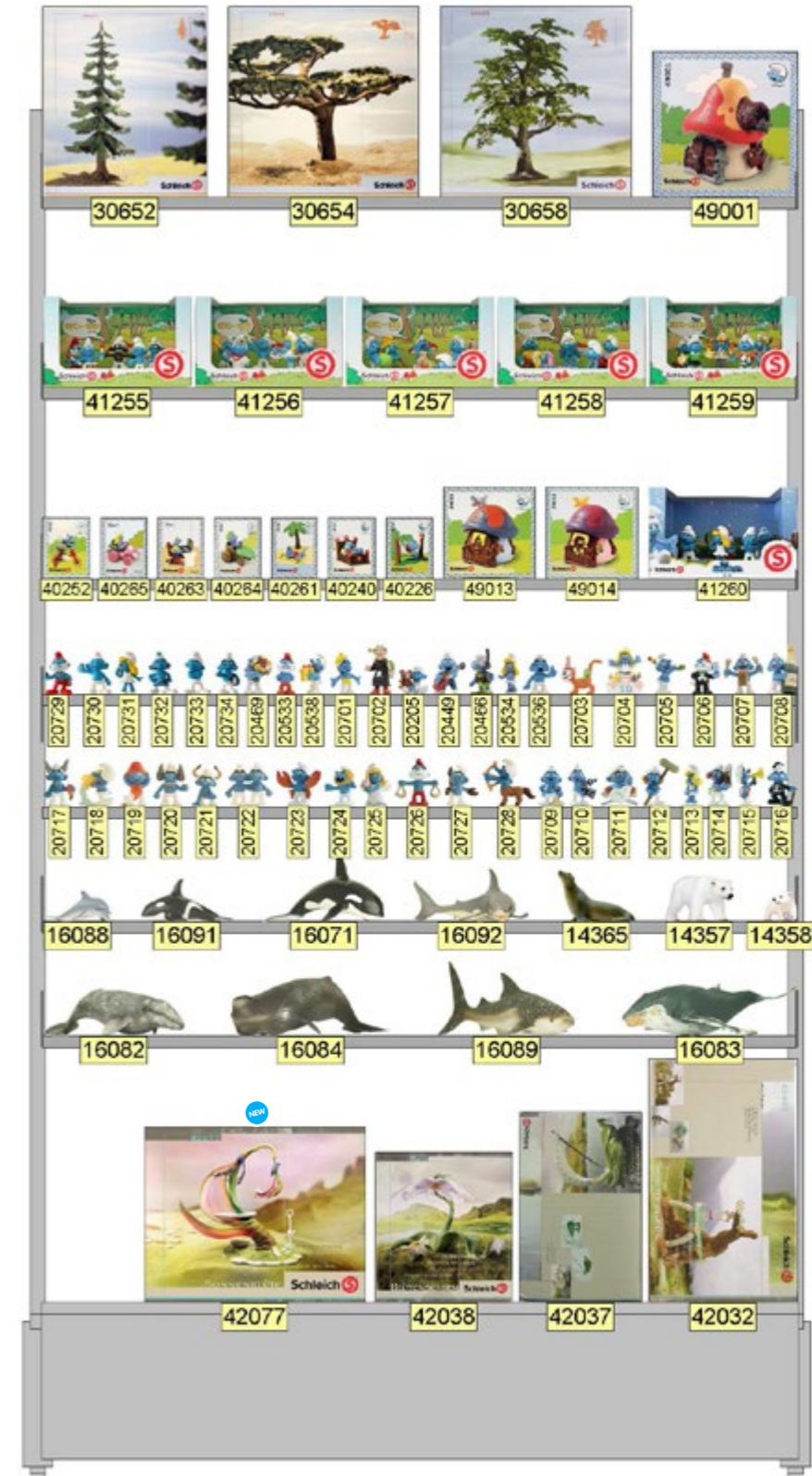

6.05 Wand / Wall / Cloison

6.06 Wand / Wall / Cloison

Blank lined writing area for page 52.

Blank lined writing area for page 53.